

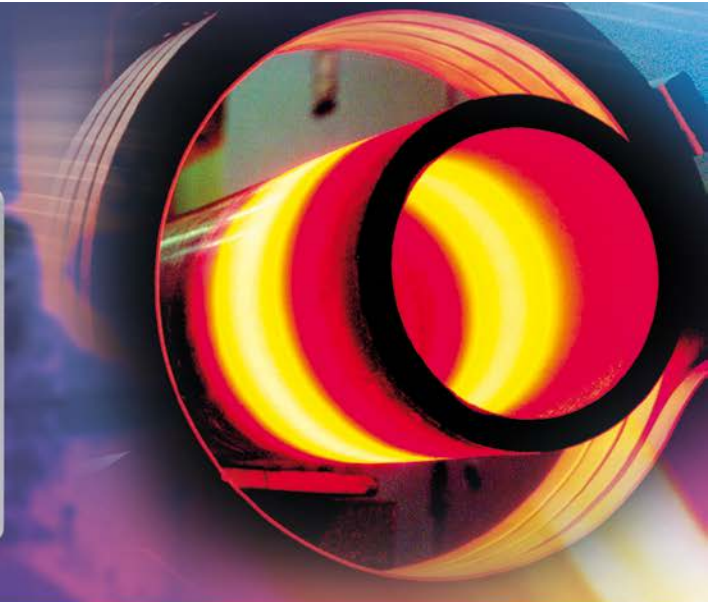

More Precision

thermo**IMAGER** TIM // Compact thermal imaging cameras





thermoIMAGER TIM M1

Short wavelength infrared camera for high temperature measurements of metal surfaces

- Highly dynamic CMOS detector with optical resolution up to 764 x 480 pixels
- Very large temperature measuring range (without sub-ranges) from 450°C to 1800°C
- Frame rates up to 1kHz for fast processes
- Real time output of the centre pixel up to 1kHz via process interface (PIF)
- License-free analysis software and complete SDK included

Software

- Display of the thermal image in real time with recording function (video, snapshot)
- Complete set up of parameters and remote control of the camera
- Detailed analysis of fast, thermodynamic processes
- Output of analogue temperature or alert values via the process interface
- Digital communication via RS232 or DLL for software integration

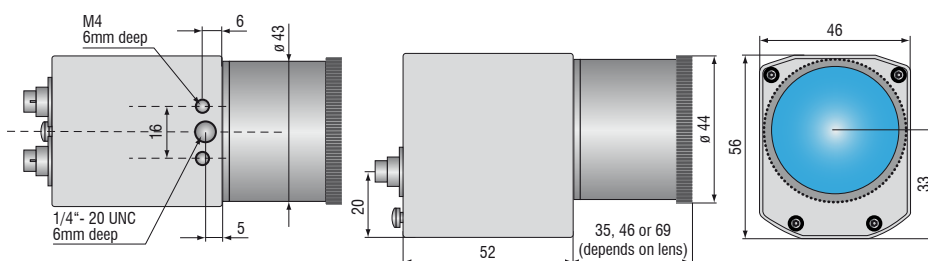
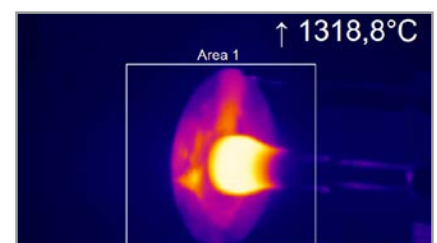
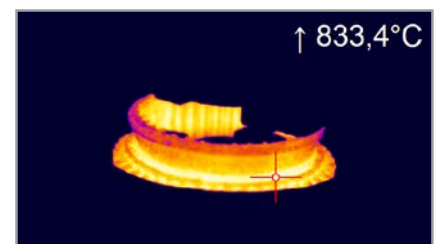
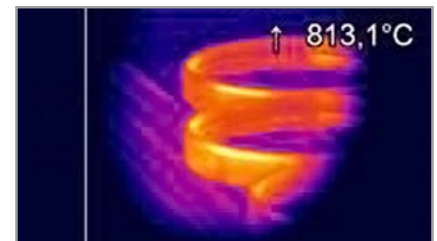

Model	TIM M1	
Optical resolution	764 x 480 pixels @ 32Hz 382 x 288 pixels @ 80Hz (switchable to 27Hz) 72 x 56 pixels @ 1kHz	
Temperature ranges	450°C to 1800°C (32 and 27Hz modes) 500°C to 1800°C (80Hz mode) 600°C to 1800°C (1kHz mode)	
Spectral range	0.92 to 1.1µm	
Frame rate	Up to 1kHz	
System accuracy	±2% of reading (object temperature < 1500°C)	
Lenses	FOV @ 764 x 480 px: 39° x 25° (f = 16mm) ¹⁾ 26° x 16° (f = 25mm) ²⁾ 13° x 8° (f = 50mm) ³⁾ 9° x 5° (f = 75mm) ⁴⁾	FOV @ 382 x 288 px: 20° x 15° (f = 16mm) ¹⁾ 13° x 10° (f = 25mm) ²⁾ 7° x 5° (f = 50mm) ³⁾ 4° x 3° (f = 75mm) ⁴⁾
Thermal sensitivity (NETD)	< 1K (700°C), < 2K (1000°C)	
Detector	CMOS (15µm x 15µm)	
Outputs/digital	USB 2.0 / optional GigE	
Standard process interface (PIF)	0-10V input, digital input (max. 24V), 0-10V output	
Industry process interface (PIF)	2x 0-10V input, digital input (max. 24V), 3x 0 - 10V output, 3x relays (0 - 30V/ 400mA), fail safe relay	
Cable length (USB)	1m (standard), 5m, 10m 5m and 10m also available as high temperature USB cable (180°C)	
Power supply	USB	
Tripod mount	¼-20 UNC	
Protection class	IP67	
Ambient temperature	0°C to 50°C	
Storage temperature	-40°C to 70°C	
Relative humidity	20 to 80%, non-condensing	
Vibration	IEC 60068-2-6 (sinus-shaped) / IEC 60068-2-64 (broadband noise)	
Shock	IEC 60068-2-27 (25g and 50g)	
Housing (size)	46mm x 56mm x 90mm	
Weight	320g; incl. lens	

PC requirements: minimum 1.5GHz, 1GB RAM, Windows XP SP 2 or Windows 7

¹⁾ Please note: measurement accuracy can be out of specification with distances below 200mm

²⁾ Please note: measurement accuracy can be out of specification with distances below 500mm

³⁾ Please note: measurement accuracy can be out of specification with distances below 1500mm

⁴⁾ Please note: measurement accuracy can be out of specification with distances below 2000mm

Scope of supply

TIM M1

- TIM process camera
incl. a selectable lens
- Operation manual
- USB cable 1m
- Software for real-time processing
and analysing thermal images
- Tripod mount
- PIF cable incl. terminal block (1m)
- Aluminium case
- Optional:
Cooling Jacket, high temperature cable

Cooling Jacket and Cooling Jacket Advanced
Universal cooling housing for infrared cameras up to 315°C

- Operation at ambient temperatures up to 315°C
- Also available as protection housing with cooling function up to 180°C
- Air/Water cooling with integrated air purging and optional protective windows
- Modular design for easy fitting of different devices and lenses
- Easy sensor removal on site due to quick-release chassis
- Integration of additional components like TIM NetBox, USB Server Gigabit and Industrial Process Interface (PIF) in the extended version



Model	Cooling Jacket	Cooling Jacket Advanced Standard	Cooling Jacket Advanced Extended
Protection class	IP 65	IP 65	IP 65
Ambient temperature	up to 180°C	up to 315°C ¹⁾	up to 315°C ¹⁾
Relative humidity	10 to 95% (non-condensing)	10 to 95% (non-condensing)	10 to 95% (non-condensing)
Material (housing)	V2A	V2A	V2A
Dimensions	237mm x 117mm x 138mm	271mm x 166mm x 182mm	426mm x 166mm x 182mm
Weight	4.5kg	5.7kg	7.8kg
Air purge collar	G1/4" internal thread G3/8" External thread	G1/4" Internal thread G3/8" External thread	G1/4" Internal thread G3/8" External thread
Cooling water fittings	G1/4" Internal thread G3/8" External thread	G1/4" Internal thread G3/8" External thread	G1/4" Internal thread G3/8" External thread
Cooling water pressure	max. 15 bar (217 psi)	max. 15 bar (217 psi)	max. 15 bar (217 psi)
Scope of supply	<ul style="list-style-type: none"> ▪ Cooling Jacket, consisting of housing and chassis 	<ul style="list-style-type: none"> ▪ Cooling Jacket Advanced, consisting of casing with mounting angle, chassis ▪ Assembly instructions ▪ Focusing unit or front attachment ²⁾ 	<ul style="list-style-type: none"> ▪ Cooling Jacket Advanced, consisting of casing with mounting angle, chassis ▪ Mounting accessories for TIM NetBox or USB Server Gigabit and Industry PIF <ul style="list-style-type: none"> ▪ Assembly instructions ▪ Focusing unit or front attachment ²⁾

¹⁾ Cable for up to 250°C ambient temperature as well as cable cooling for up to 315°C available.

²⁾ Must be ordered separately.

Cooling Jacket

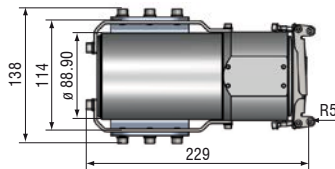

Cooling Jacket Advanced – Standard version

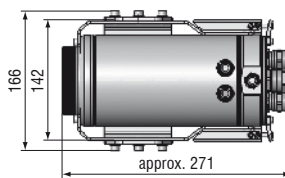

Cooling Jacket Advanced – Extended version

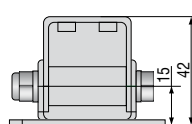
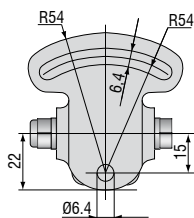
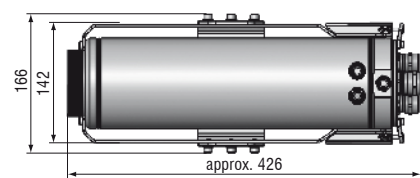

TM-MB-TIM Mounting base, adjustable

TM-PH-TIM Protective housing incl. mounting base

TIM 160 / 200	Focal length [mm]	Angle	Minimum measurement distance*	Distance to measurement object [m]												
					0.02	0.1	0.2	0.3	0.5	1	2	4	6	10	30	100
160 x 120 px	10	23° 17° 29° 2.48 mrad	0.2m	HFOV [m]	0.012	0.043	0.08	0.12	0.21	0.41	0.81	1.62	2.44	4.1	12.2	40.6
				VFOV [m]	0.009	0.032	0.06	0.09	0.15	0.30	0.60	1.21	1.81	3.0	9.0	30.1
				DFOV [m]	0.015	0.054	0.10	0.16	0.26	0.51	1.01	2.02	3.03	5.1	15.2	50.5
				IFOV [mm]	0.1	0.3	0.5	0.8	1.3	2.5	5.0	9.9	14.9	24.8	74.4	248.0
6° Telephoto lens	35.5	6° 5° 8° 0.70 mrad	0.5m	HFOV [m]					0.06	0.11	0.23	0.45	0.68	1.1	3.4	11.3
				VFOV [m]					0.04	0.09	0.17	0.34	0.51	0.8	2.5	8.5
				DFOV [m]					0.07	0.14	0.28	0.57	0.85	1.4	4.2	14.2
				IFOV [mm]					0.4	0.7	1.4	2.8	4.2	7.0	21.1	70.4
48° Wide angle lens	5.7	41° 31° 51° 4.39 mrad	0.2m	HFOV [m]	0.022	0.082	0.16	0.23	0.38	0.76	1.51	3.00	4.50	7.5	22.5	74.9
				VFOV [m]	0.016	0.059	0.11	0.17	0.28	0.55	1.10	2.19	3.28	5.5	16.4	54.5
				DFOV [m]	0.027	0.101	0.19	0.29	0.47	0.94	1.86	3.72	5.57	9.3	27.8	92.7
				IFOV [mm]	0.1	0.4	0.9	1.3	2.2	4.4	8.8	17.5	26.3	43.9	131.6	438.6
72° Wide angle lens	3.3	72° 52° 89° 7.51 mrad	0.2m	HFOV [m]	0.039	0.152	0.29	0.43	0.72	1.42	2.84	5.66	8.49	14.1	42.4	141.4
				VFOV [m]	0.027	0.106	0.20	0.30	0.50	0.99	1.98	3.95	5.92	9.9	29.6	98.6
				DFOV [m]	0.048	0.186	0.36	0.53	0.87	1.74	3.46	6.91	10.35	17.2	51.7	172.3
				IFOV [mm]	0.2	0.8	1.5	2.3	3.8	7.5	15.0	30.0	45.0	75.1	225.2	750.8

TIM 400 / 450 / G7	Focal length [mm]	Angle	Minimum measurement distance*	Distance to measurement object [m]												
					0.02	0.1	0.2	0.3	0.5	1	2	4	6	10	30	100
382 x 288 px	15	38° 29° 48° 1.67 mrad	0.2m	HFOV [m]	0.024	0.079	0.15	0.21	0.35	0.70	1.39	2.76	4.14	6.9	20.7	68.9
				VFOV [m]	0.018	0.060	0.11	0.16	0.26	0.52	1.04	2.07	3.11	5.2	15.5	51.7
				DFOV [m]	0.030	0.099	0.18	0.27	0.44	0.87	1.73	3.46	5.18	8.6	25.9	86.2
				IFOV [mm]	0.1	0.2	0.4	0.5	0.9	1.7	3.4	6.7	10.0	16.7	50.0	166.7
13° Telephoto lens (not G7)	41	13° 10° 17° 0.61 mrad	0.5m	HFOV [m]					0.12	0.23	0.47	0.94	1.40	2.3	7.0	23.4
				VFOV [m]					0.09	0.17	0.35	0.70	1.05	1.7	5.2	17.5
				DFOV [m]					0.15	0.29	0.58	1.17	1.75	2.9	8.8	29.2
				IFOV [mm]					0.3	0.6	1.2	2.5	3.7	6.1	18.4	61.2
62° Wide angle lens	11	62° 49° 79° 2.27 mrad	0.5m	HFOV [m]	0.040	0.136	0.26	0.38	0.62	1.22	2.42	4.83	7.23	12.0	36.1	120.3
				VFOV [m]	0.030	0.103	0.19	0.28	0.47	0.92	1.83	3.65	5.47	9.1	27.3	90.9
				DFOV [m]	0.050	0.170	0.32	0.47	0.77	1.53	3.03	6.05	9.06	15.1	45.2	150.8
				IFOV [mm]	0.1	0.2	0.5	0.7	1.2	2.29	4.56	9.11	13.65	22.7	68.2	227.3
80° Wide angle lens	7.7	80° 56° 97° 3.25 mrad	0.2m	HFOV [m]		0.182	0.35	0.84	0.84	1.65	3.29	6.55	9.82	16.4	49.0	163.4
				VFOV [m]		0.119	0.23	0.55	0.54	1.08	2.14	4.28	6.41	10.7	32.0	106.6
				DFOV [m]		0.218	0.41	1.00	1.00	1.97	3.92	7.83	11.73	19.5	58.5	195.1
				IFOV [mm]		0.3	0.7	1.6	1.6	3.3	6.5	13.0	19.5	32.5	97.4	324.7

FOV = Field of view; HFOV = Horizontal field of view; VFOV = Vertical field of view; DFOV = Diagonal dimension of the total measuring field at the object level; IFOV = Indicated field of view
 Table with examples showing which measuring field sizes and pixel sizes are reached at which distance. Various lenses are available for optimal configuration of the camera. Wide angle lenses have radial distortion due to the angle of their aperture. The TIMConnect software has an algorithm which corrects this distortion.

* Please note: The measurement accuracy of the camera may lie outside of the specifications for distances below the defined minimum measurement distance.

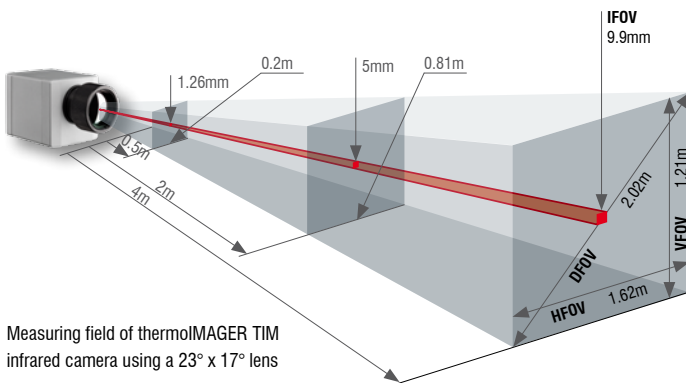

Measuring field of thermoIMAGER TIM infrared camera using a 23° x 17° lens

- Standard-, telephoto- and wide angle lenses for different applications
- High quality germanium lenses and special anti-reflective coating for excellent optics
- Factory-calibrated lenses for easy exchange of optical system without recalibration

Measuring field sizes can be calculated online at www.micro-epsilon.com/optikkalkulator.

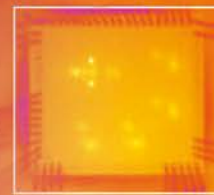

TIM 640	Focal length [mm]	Angle	Minimum measurement distance*	Distance to measurement object [m]													
					0.1	0.2	0.3	0.5	1	2	4	6	10	30	100		
640 x 480 px																	
33° Standard lens	18.7	33° 25° 41° 0.91 mrad	0.2m	HFOV [m]	0.068	0.13	0.19	0.31	0.60	1.20	2.38	3.57	5.9	17.8	59.3		
				VFOV [m]	0.051	0.09	0.14	0.23	0.45	0.89	1.77	2.65	4.4	13.2	44.2		
				DFOV [m]	0.085	0.16	0.23	0.38	0.75	1.49	2.97	4.45	7.4	22.2	74.0		
				IFOV [mm]	0.1	0.2	0.3	0.5	0.9	1.8	3.6	5.5	9.1	27.3	90.9		
15° Teleoptik	41.5	15° 11° 19° 0.41 mrad	0.5m	HFOV [m]				0.13	0.26	0.52	1.05	1.57	2.6	7.8	26.1		
				VFOV [m]				0.10	0.20	0.39	0.79	1.18	2.0	5.9	19.6		
				DFOV [m]				0.17	0.33	0.66	1.31	1.96	3.3	9.8	32.7		
				IFOV [mm]				0.2	0.4	0.8	1.6	2.5	4.1	12.3	41.0		
60° Weitwinkeloptik	10.5	60° 45° 75° 1.62 mrad	0.2m	HFOV [m]	0.128	0.25	0.36	0.59	1.17	2.32	4.63	6.94	11.6	34.6	115.4		
				VFOV [m]	0.091	0.18	0.26	0.42	0.83	1.66	3.31	4.96	8.3	24.7	82.4		
				DFOV [m]	0.157	0.30	0.44	0.72	1.43	2.85	5.69	8.52	14.2	42.6	141.8		
				IFOV [mm]	0.2	0.3	0.5	0.8	1.6	3.2	6.5	9.7	16.2	48.6	161.9		
90° Super wide angle lens	7.7	90° 64° 111° 2.21 mrad	0.2m	HFOV [m]	0.220	0.43	0.63	1.03	2.03	4.04	8.06	12.07	20.1	60.3	200.8		
				VFOV [m]	0.138	0.27	0.39	0.64	1.27	2.53	5.05	7.57	12.6	37.8	125.9		
				DFOV [m]	0.260	0.50	0.73	1.21	2.39	4.76	9.50	14.24	23.7	71.1	237.0		
				IFOV [mm]	0.2	0.4	0.7	1.1	2.2	4.4	8.8	13.2	22.1	66.2	220.8		

TIM M1	Focal length [mm]	Angle	Minimum measurement distance*	Distance to measurement object [m]													
					0.1	0.2	0.3	0.5	1	2	4	6	10	30	100		
382 x 288 px																	
f=16mm Wide angle lens	16	20° 15° 25° 0.94 mrad	0.2m	HFOV [m]		0.07	0.11	0.18	0.36	0.72	1.43	2.15	3.6	10.7	35.8		
				VFOV [m]		0.05	0.08	0.14	0.27	0.54	1.08	1.62	2.7	8.1	27.0		
				DFOV [m]		0.09	0.13	0.22	0.45	0.90	1.79	2.69	4.5	13.5	44.9		
				IFOV [mm]		0.2	0.3	0.5	0.9	1.9	3.8	5.6	9.4	28.1	93.8		
f=25mm Standard lens	25	13° 10° 16° 0.60 mrad	0.5m	HFOV [m]	0.023	0.05	0.07	0.11	0.23	0.46	0.92	1.38	2.3	6.9	22.9		
				VFOV [m]	0.017	0.03	0.05	0.09	0.17	0.35	0.69	1.04	1.7	5.2	17.3		
				DFOV [m]	0.029	0.06	0.09	0.14	0.29	0.57	1.15	1.72	2.9	8.6	28.7		
				IFOV [mm]	0.1	0.1	0.2	0.3	0.6	1.2	2.4	3.6	6.0	18.0	60.0		
f=50mm Telephoto lens	50	7° 5° 8° 0.30 mrad	1.5m	HFOV [m]				0.06	0.11	0.23	0.46	0.69	1.1	3.4	11.5		
				VFOV [m]				0.04	0.09	0.17	0.35	0.52	0.9	2.6	8.6		
				DFOV [m]				0.07	0.14	0.29	0.57	0.86	1.4	4.3	14.4		
				IFOV [mm]				0.2	0.3	0.6	1.2	1.8	3.0	9.0	30.0		
f=75mm Super telephoto lens	75	4° 3° 5° 0.20 mrad	2.0m	HFOV [m]					0.08	0.15	0.31	0.46	0.8	2.3	7.6		
				VFOV [m]					0.06	0.12	0.23	0.35	0.6	1.7	5.8		
				DFOV [m]					0.10	0.19	0.38	0.57	1.0	2.9	9.6		
				IFOV [mm]					0.2	0.4	0.8	1.2	2.0	6.0	20.0		

Please note: the camera provides 382 x 288 px in the 80Hz mode

TIM M1 with VGA resolution 764 x 480 px	Focal length [mm]	Angle	Minimum measurement distance*	Distance to measurement object [m]											
					0.1	0.2	0.3	0.5	1	2	4	6	10	30	100
f=16mm Wide angle lens	16	39° 25° 46° 0.94 mrad	0.2m	HFOV [m]		0.14	0.21	0.36	0.72	1.43	2.87	4.30	7.2	21.5	71.6
				VFOV [m]		0.09	0.14	0.23	0.45	0.90	1.80	2.70	4.5	13.5	45.0
				DFOV [m]		0.17	0.25	0.42	0.85	1.69	3.38	5.08	8.5	25.4	84.6
				IFOV [mm]		0.2	0.3	0.5	0.9	1.9	3.8	5.6	9.4	28.1	93.8
f=25mm Standard lens	25	26° 16° 30° 0.60 mrad	0.5m	HFOV [m]	0.046	0.09	0.14	0.23	0.46	0.92	1.83	2.75	4.6	13.8	45.8
				VFOV [m]	0.029	0.06	0.09	0.14	0.29	0.58	1.15	1.73	2.9	8.6	28.8
				DFOV [m]	0.054	0.11	0.16	0.27	0.54	1.08	2.17	3.25	5.4	16.2	54.1
				IFOV [mm]	0.1	0.1	0.2	0.3	0.6	1.2	2.4	3.6	6.0	18.0	60.0
f=50mm Telephoto lens	50	13° 8° 15° 0.30 mrad	1.5m	HFOV [m]				0.11	0.23	0.46	0.92	1.38	2.3	6.9	22.9
				VFOV [m]				0.07	0.14	0.29	0.58	0.86	1.4	4.3	14.4
				DFOV [m]				0.14	0.27	0.54	1.08	1.62	2.7	8.1	27.1
				IFOV [mm]				0.2	0.3	0.6	1.2	1.8	3.0	9.0	30.0
f=75mm Super telephoto lens	75	9° 5° 10° 0.20 mrad	2.0m	HFOV [m]					0.15	0.31	0.61	0.92	1.5	4.6	15.3
				VFOV [m]					0.10	0.19	0.38	0.58	1.0	2.9	9.6
				DFOV [m]					0.18	0.36	0.72	1.08	1.8	5.4	18.0
				IFOV [mm]					0.2	0.4	0.8	1.2	2.0	6.0	20.0

Please note: the camera provides 764 x 480 px in the 32Hz mode



MICRO-EPSILON Headquarters
Koenigbacher Str. 15 · 94496 Ortenburg / Germany
Tel. +49 (0) 8542 / 168-0 · Fax +49 (0) 8542 / 168-90
info@micro-epsilon.com · www.micro-epsilon.com

MICRO-EPSILON UK Ltd.
No.1 Shorelines Building · Shore Road · Birkenhead · CH41 1AU
Phone +44 (0) 151 355 6070 · Fax +44 (0) 151 355 6075
info@micro-epsilon.co.uk · www.micro-epsilon.co.uk