

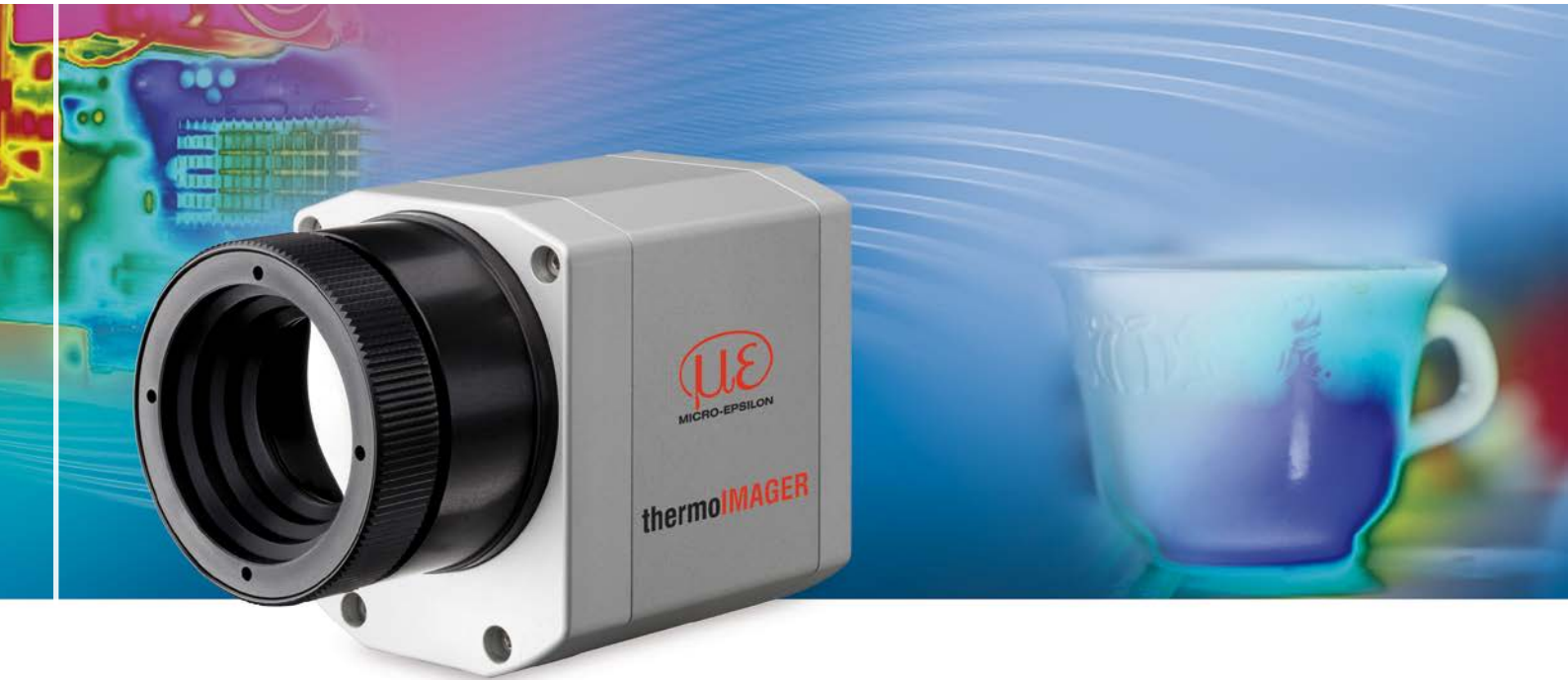

More Precision

thermo**IMAGER** TIM // Compact thermal imaging cameras





thermoIMAGER TIM 400/450

Thermal imaging camera with high resolution and sensitivity

- Detector with 382 x 288 pixels
- Measuring range from -20°C to 900°C (special edition up to 1500°C)
- Fast, real-time thermal imager with up to 80Hz
- Very high thermal sensitivity with 80mK (TIM 400) and 40mK (TIM 450)
- Smallest camera in its class (46 x 56 x 90mm)
- Lightweight (320g incl. lens)
- Exchangeable lenses & industrial accessories
- Software TIMConnect included in the scope of supply
- Software Developer Kit and LabVIEW samples included

Software

- Display of the thermal image in real time (80Hz) with recording function (video, snapshot)
- Complete set up of parameters and remote control of the camera
- Detailed analysis of fast, thermodynamic processes
- Output of analogue temperature or alert values via the process interface
- Digital communication via RS232 or DLL for software integration

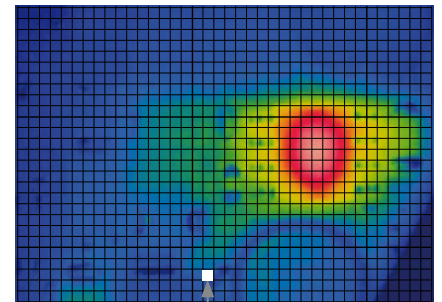

382 x 288 pixels

10 x 10 pixels = 40mm²

SMD element as measurement object

Measuring field size: 240mm x 180mm,
pixel size: 0.63mm

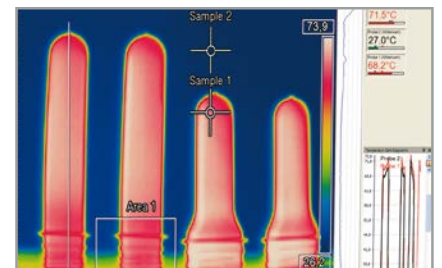

80Hz imaging with full pixel resolution

Thermal image shots of preforms in PET bottle production

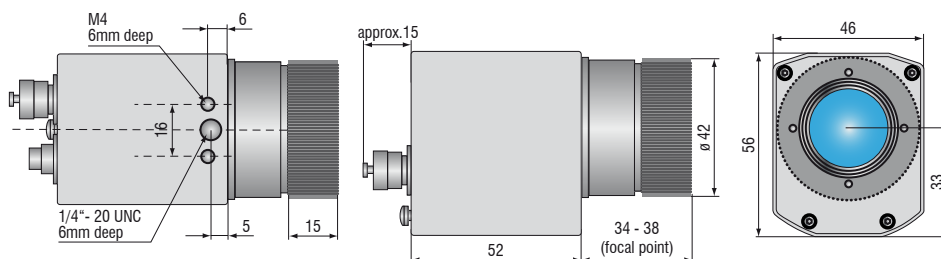

Model	TIM 400	TIM 450
Optical resolution	382 x 288 pixels	
Temperature ranges	-20°C to 100°C, 0°C to 250°C, 150°C to 900°C, optional range: 200°C to 1500°C (only for TIM 400)	
Spectral range	7.5 to 13µm	
Frame rate	80Hz	
System accuracy	±2°C or ±2%, whichever is greater	
Lenses	80° x 56° FOV / f = 7.7mm ¹⁾ or 38° x 29° FOV / f = 15mm ¹⁾ or 62° x 49° FOV / f = 8mm ¹⁾ or 13° x 10° FOV / f = 41mm ²⁾	
Thermal sensitivity (NETD)	0.08K with 80° x 56° FOV / F = 0.8 0.08K with 62° x 49° FOV / F = 0.8 0.08K with 38° x 29° FOV / F = 0.8 0.1K with 13° x 10° FOV / F = 1.0	0.04K with 80° x 56° FOV / F = 0.8 0.04K with 62° x 49° FOV / F = 0.8 0.04K with 38° x 29° FOV / F = 0.8 0.06K with 13° x 10° FOV / F = 1.0
Detector	FPA - uncooled micro bolometer 25x25µm ²	
Outputs/digital	USB 2.0 / optional GigE	
Process interface (electrically isolated)	0-10V output, 0-10V input, trigger input	
Power supply	USB powered	
Tripod mount	¼-20 UNC	
Protection class	IP67	
Ambient temperature	0°C to 50°C	0°C to 70°C
Storage temperature	-40°C to 70°C	-40°C to 85°C
Relative humidity	20 to 80%, non-condensing	
Vibration	IEC 60068-2-6 (sine-shaped) / IEC 60068-2-64 (broadband noise)	
Shock	IEC 60068-2-27 (25g and 50g)	
Housing (size)	46mm x 56mm x 90mm	
Weight	320g; incl. lens	

PC requirements: minimum 1.5GHz, 1GB RAM, Windows XP SP 2 or Windows 7

¹⁾ Please note: measurement accuracy can be out of specification with distances below 200mm

²⁾ Please note: measurement accuracy can be out of specification with distances below 500mm

Scope of supply

TIM 400/450

- TIM process camera
incl. a selectable lens
- Operation manual
- USB cable 1m
- Software for real-time processing
and analysing thermal images
- Tripod mount
- PIF cable 1m
- Aluminium case

Cooling Jacket and Cooling Jacket Advanced
Universal cooling housing for infrared cameras up to 315°C

- Operation at ambient temperatures up to 315°C
- Also available as protection housing with cooling function up to 180°C
- Air/Water cooling with integrated air purging and optional protective windows
- Modular design for easy fitting of different devices and lenses
- Easy sensor removal on site due to quick-release chassis
- Integration of additional components like TIM NetBox, USB Server Gigabit and Industrial Process Interface (PIF) in the extended version



Model	Cooling Jacket	Cooling Jacket Advanced Standard	Cooling Jacket Advanced Extended
Protection class	IP 65	IP 65	IP 65
Ambient temperature	up to 180°C	up to 315°C ¹⁾	up to 315°C ¹⁾
Relative humidity	10 to 95% (non-condensing)	10 to 95% (non-condensing)	10 to 95% (non-condensing)
Material (housing)	V2A	V2A	V2A
Dimensions	237mm x 117mm x 138mm	271mm x 166mm x 182mm	426mm x 166mm x 182mm
Weight	4.5kg	5.7kg	7.8kg
Air purge collar	G1/4" internal thread G3/8" External thread	G1/4" Internal thread G3/8" External thread	G1/4" Internal thread G3/8" External thread
Cooling water fittings	G1/4" Internal thread G3/8" External thread	G1/4" Internal thread G3/8" External thread	G1/4" Internal thread G3/8" External thread
Cooling water pressure	max. 15 bar (217 psi)	max. 15 bar (217 psi)	max. 15 bar (217 psi)
Scope of supply	<ul style="list-style-type: none"> ▪ Cooling Jacket, consisting of housing and chassis 	<ul style="list-style-type: none"> ▪ Cooling Jacket Advanced, consisting of casing with mounting angle, chassis ▪ Assembly instructions ▪ Focusing unit or front attachment ²⁾ 	<ul style="list-style-type: none"> ▪ Cooling Jacket Advanced, consisting of casing with mounting angle, chassis ▪ Mounting accessories for TIM NetBox or USB Server Gigabit and Industry PIF <ul style="list-style-type: none"> ▪ Assembly instructions ▪ Focusing unit or front attachment ²⁾

¹⁾ Cable for up to 250°C ambient temperature as well as cable cooling for up to 315°C available.

²⁾ Must be ordered separately.

Cooling Jacket

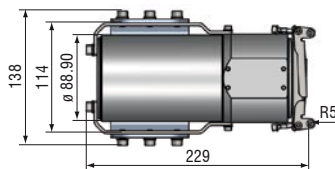

Cooling Jacket Advanced – Standard version

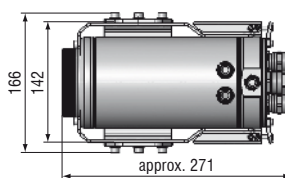

Cooling Jacket Advanced – Extended version

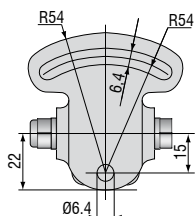
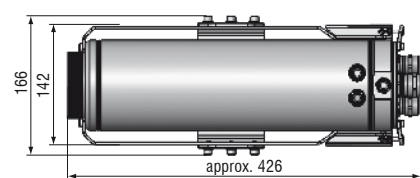

TM-MB-TIM Mounting base, adjustable

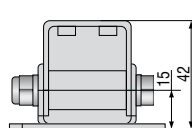

TM-PH-TIM Protective housing incl. mounting base



thermoIMAGER TIM USB Server Gigabit

Simple cable extension for the thermoIMAGER TIM series and pyrometers

- Fully compatible with USB 2.0, data transfer rate 1.5/ 12/ 480 mbps, USB transfer modes: Control, Bulk, Interrupt, Isochronous
- For all models in the thermoIMAGER TIM series 1x TIM640, 1x TIM4xx, 2x TIM160, 1x TIM200
- Full TCP/IP support incl. routing and DNS
- Galvanic isolation 500V_{RMS} (network connection)
- Remote configuration via web-based management

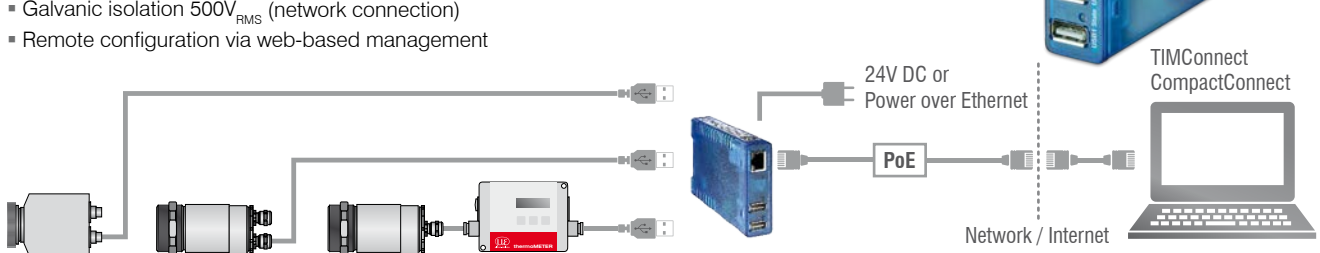

Model	TIM USB Server Gigabit
USB ports	Two independent USB ports
USB speed	480Mbit/s
Network	10/100/1000 BaseT (max. 1000Mbit/s)
Power supply	Power over Ethernet (PoE) class 3 (6.49 - 12.95W) or via screw terminal DC 24V ... 48V (±10%)
Power consumption	External power supply (24V DC) without USB devices: typ. 120mA External power supply (24V DC) with 2 USB devices each 2.5W: typ. 420mA
Ambient temperature	Storage: -40 ... 85°C In operation, individually assembled: 0 ... 50°C
Permissible relative humidity	0 - 95% (non-condensing)
Housing	Compact plastic housing for DIN rail mount, 105 x 75 x 22mm
Weight	200g
Scope of supply	1 x USB Server Gigabit 24 V DC wall plug transformer Quick guide ¹⁾
USB protocols	USB 1.0 / 1.1 / 2.0 Control / Bulk / Interrupt / Isochronous
Protocols for direct network connection	TCP/IP: Socket Auxiliary protocols: ARP, DHCP, HTTP, PING Inventory keeping, group management

¹⁾ TIMConnect CD or Compact Connect CD: USB redirector | WuTility Management Tool | Operating instructions (DE/EN)

Industrial process interface

Camera and process control for use in industrial environments

- Separate fail-safe relay output
- TIM hardware with all cable connections and the TIMConnect software are permanently monitored during operation

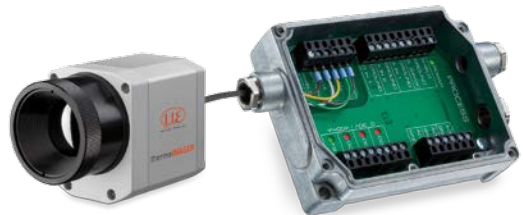

Model	Industrial process interface
Protection class	IP65 (NEMA-4)
Ambient temperature	-30°C to 85°C
Storage temperature	-30°C to 85°C
Relative humidity	10 to 95% (non-condensing)
Vibration resistance	IEC 60068-2-6 (non-condensing)/ IEC 60068-2-64 (broadband noise)
Shock	IEC 60068-2-27 (25g and 50g)
Weight	610g (with 5m cable)
Cable length	5m, optional 10m and 20m or HT cable (180° or 250°)
Power supply	5 – 24V DC
LED indicators	2 green LEDs for voltage and fail safe / 3 red LEDs for alarm relay status
Isolation	500V AC _{RMS} between TIM camera und process
Outputs	3 analogue/ alarm outputs 3 alarm relays ¹⁾
Inputs	2 analogue inputs 1 digital input
Ranges	0 – 10V (for AO 1 – 3) ²⁾ 0 – 30V / 400mA (for alarm relays DO1 – 3) 0 – 10V (for AI 1 – 2) 24V (for DI)
Analogue inputs	Emissivity setting Ambient temperature compensation Reference temperature Uncommitted value Flag control Triggered snapshots, triggered recordings, triggered line scan camera
Digital input	Flag control Triggered snapshots, triggered recordings, triggered line scan camera
Analogue outputs	Main measuring range Measuring range Internal temperature Flag status

¹⁾ active when AO1, 2 or 3 is / are programmed as alarm output ²⁾ dependent on supply voltage

thermoIMAGER TIM NetPC / NetPCQ PC solution for thermoIMAGER TIM applications

TIM NetPC is a professional, embedded industrial PC solution with a passive cooling (fanless) for thermoIMAGER applications and is suitable for top hat rail mounting. The NetPC and the TIM camera can be operated in combination as stand-alone system. Remote maintenance via Ethernet is possible. Data provided by the TIM camera can be stored directly on the NetPC where customer-specific software can also be installed. A recovery-stick is included in the scope of delivery.

- Supports all thermoIMAGER TIM models
- Supports 120Hz (TIM 160), up to 80Hz (TIM 4x0), up to 32Hz (TIM 640) frame rates
- Including TIMConnect software
- Monitor via VGA (analogue)
- Integrated watchdog feature
- Optional: up to 20m USB cable, high temperature USB cable, extendable up to 100m Ethernet cable (PoE)



thermoIMAGER TIM NetPC

Model	TIM NetPC	TIM NetPCQ
Ambient temperature		0 to 50°C
Storage temperature		-20 to 60°C
Relative humidity		10 to 95% (non-condensing)
Dimensions		165 x 65 x 130mm (W x H x D)
Material (housing)		Anodised aluminium
Weight		1000g
Vibration		IEC-2-6: 3G, 11 - 200Hz, each axis
Shock		IEC-2-27: 50G, 11ms, each axis
Operating system		Windows 7 embedded
Power supply		12 - 24V DC
Power consumption		approx. 9.5W without TIM [0.76A with 12V]
Cooling		passive cooling (fanless)
Processor	Intel® Atom™ 2600 @ 2x1.6GHz Dual	Intel® Atom™ J1900 @ 4x2.4GHz
Hard disc drive		integrated 64GB SSD
RAM		2GB DDR3 RAM 800MHz
Ports	1 Gbit/s (Gig E), 2 x RS 232, 4 x USB 2.0, VGA	1 Gig E, 2 x RS 232 / 485, 3 x USB 2.0, 1 x USB 3.0, VGA
Additional functions		1x status LED

SOFTWARE FEATURES TIMConnect

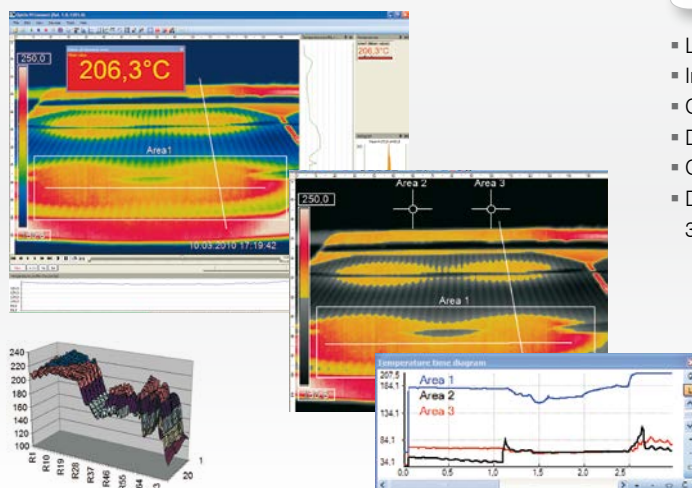

Comprehensive IR camera software

- License-free analysis software and complete SDK included
- Intuitive user interface
- Camera remote control via software
- Displays several camera images in different windows
- Compatible with Windows 7 and 8 and Linux (ubuntu)
- Data output via PIF hardware interface using up to 3 analogue channels



thermoIMAGER TIM NetBox Miniature PC for thermoIMAGER TIM

- Can be integrated into CoolingJacket Advanced Extended
- Miniature PC for TIM 160/ 4x0 standalone mode or for cable extension
- Supports 120Hz (TIM 160) up to 70Hz (TIM 4x0) frame rate, 32Hz (TIM 640)
- Integrated hardware and software watchdog
- Optional: up to 20m USB cable, high temperature USB cable, extendable up to 100m Ethernet cable (PoE)

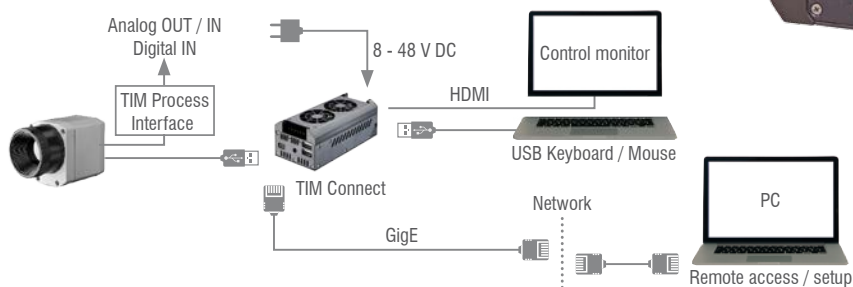

thermoIMAGER TIM NetBox

Model	TIM NetBox
Operating temperature	0 to 50°C
Storage temperature	-20 to 75°C
Relative humidity	10 to 95% (non-condensing)
Material (housing)	Anodised aluminium
Dimensions	113 x 57 x 39mm
Weight	385g
Vibration	IEC 60068-2-6 (sine-shaped) / IEC 60068-2-64 (broadband noise)
Shock	IEC 60068-2-27 (25g and 50g)
Operating system	Windows 7 Professional
Power supply	8 ... 48VDC or Power over Ethernet (PoE/ 1000BASE-T)
Power consumption	7.5W (+ additional 2.5W for TIM camera)
Cooling	Active via two integrated fans
Module	COM Express® mini embedded board
Processor	Intel® E3845 Quad Core, 1.91GHz
Hard disc drive	16GB SSD
RAM	2GB (DDR2, 533MHz)
Ports	2x USB 2.0, 1x USB 3.0, 1x Mini USB 2.0, Micro HDMI, Ethernet (Gigabit Ethernet)
Extensions	micro SDHC/ SDXC card
Additional functions	4x status LEDs

Online and offline data analysis

- Real time temperature information (°C or °F) in main window, as digital display or graphic display
- Detailed analysis using measuring fields, automatic hotspot/cold-spot search
- Logical linking of temperature information
- Slow-motion replay without connected camera
- Various colour palettes to highlight thermal contrasts

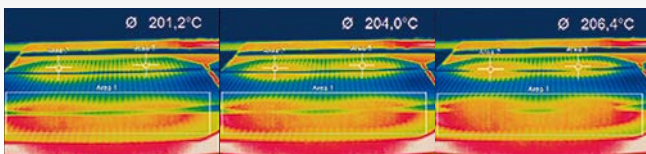

Video recording and snapshot feature (IR or BI-SPECTRAL)

- Recording of video sequences and individual images for later analysis or documentation
- Adjustable frame rate to reduce data volume
- Display of snapshot process for direct analysis

Temperature data analysis and documentation

- Triggered data collection
- Radiometric video sequences (*.ravi) and snapshots (*.tiff)
- Thermal images as *.avi / *.tiff or text file *.csv, *.dat incl. complete temperature information
- Data transfer in real time to other software programs via DLL or COM port interfaces

TIM 160 / 200	Focal length [mm]	Angle	Minimum measurement distance*	Distance to measurement object [m]												
					0.02	0.1	0.2	0.3	0.5	1	2	4	6	10	30	100
160 x 120 px	10	23° 17° 29° 2.48 mrad	0.2m	HFOV [m]	0.012	0.043	0.08	0.12	0.21	0.41	0.81	1.62	2.44	4.1	12.2	40.6
				VFOV [m]	0.009	0.032	0.06	0.09	0.15	0.30	0.60	1.21	1.81	3.0	9.0	30.1
				DFOV [m]	0.015	0.054	0.10	0.16	0.26	0.51	1.01	2.02	3.03	5.1	15.2	50.5
				IFOV [mm]	0.1	0.3	0.5	0.8	1.3	2.5	5.0	9.9	14.9	24.8	74.4	248.0
6° Telephoto lens	35.5	6° 5° 8° 0.70 mrad	0.5m	HFOV [m]					0.06	0.11	0.23	0.45	0.68	1.1	3.4	11.3
				VFOV [m]					0.04	0.09	0.17	0.34	0.51	0.8	2.5	8.5
				DFOV [m]					0.07	0.14	0.28	0.57	0.85	1.4	4.2	14.2
				IFOV [mm]					0.4	0.7	1.4	2.8	4.2	7.0	21.1	70.4
48° Wide angle lens	5.7	41° 31° 51° 4.39 mrad	0.2m	HFOV [m]	0.022	0.082	0.16	0.23	0.38	0.76	1.51	3.00	4.50	7.5	22.5	74.9
				VFOV [m]	0.016	0.059	0.11	0.17	0.28	0.55	1.10	2.19	3.28	5.5	16.4	54.5
				DFOV [m]	0.027	0.101	0.19	0.29	0.47	0.94	1.86	3.72	5.57	9.3	27.8	92.7
				IFOV [mm]	0.1	0.4	0.9	1.3	2.2	4.4	8.8	17.5	26.3	43.9	131.6	438.6
72° Wide angle lens	3.3	72° 52° 89° 7.51 mrad	0.2m	HFOV [m]	0.039	0.152	0.29	0.43	0.72	1.42	2.84	5.66	8.49	14.1	42.4	141.4
				VFOV [m]	0.027	0.106	0.20	0.30	0.50	0.99	1.98	3.95	5.92	9.9	29.6	98.6
				DFOV [m]	0.048	0.186	0.36	0.53	0.87	1.74	3.46	6.91	10.35	17.2	51.7	172.3
				IFOV [mm]	0.2	0.8	1.5	2.3	3.8	7.5	15.0	30.0	45.0	75.1	225.2	750.8

TIM 400 / 450 / G7	Focal length [mm]	Angle	Minimum measurement distance*	Distance to measurement object [m]												
					0.02	0.1	0.2	0.3	0.5	1	2	4	6	10	30	100
38° Standard lens	15	38° 29° 48° 1.67 mrad	0.2m	HFOV [m]	0.024	0.079	0.15	0.21	0.35	0.70	1.39	2.76	4.14	6.9	20.7	68.9
				VFOV [m]	0.018	0.060	0.11	0.16	0.26	0.52	1.04	2.07	3.11	5.2	15.5	51.7
				DFOV [m]	0.030	0.099	0.18	0.27	0.44	0.87	1.73	3.46	5.18	8.6	25.9	86.2
				IFOV [mm]	0.1	0.2	0.4	0.5	0.9	1.7	3.4	6.7	10.0	16.7	50.0	166.7
13° Telephoto lens (not G7)	41	13° 10° 17° 0.61 mrad	0.5m	HFOV [m]					0.12	0.23	0.47	0.94	1.40	2.3	7.0	23.4
				VFOV [m]					0.09	0.17	0.35	0.70	1.05	1.7	5.2	17.5
				DFOV [m]					0.15	0.29	0.58	1.17	1.75	2.9	8.8	29.2
				IFOV [mm]					0.3	0.6	1.2	2.5	3.7	6.1	18.4	61.2
62° Wide angle lens	11	62° 49° 79° 2.27 mrad	0.5m	HFOV [m]	0.040	0.136	0.26	0.38	0.62	1.22	2.42	4.83	7.23	12.0	36.1	120.3
				VFOV [m]	0.030	0.103	0.19	0.28	0.47	0.92	1.83	3.65	5.47	9.1	27.3	90.9
				DFOV [m]	0.050	0.170	0.32	0.47	0.77	1.53	3.03	6.05	9.06	15.1	45.2	150.8
				IFOV [mm]	0.1	0.2	0.5	0.7	1.2	2.29	4.56	9.11	13.65	22.7	68.2	227.3
80° Wide angle lens	7.7	80° 56° 97° 3.25 mrad	0.2m	HFOV [m]		0.182	0.35	0.84	0.84	1.65	3.29	6.55	9.82	16.4	49.0	163.4
				VFOV [m]		0.119	0.23	0.55	0.54	1.08	2.14	4.28	6.41	10.7	32.0	106.6
				DFOV [m]		0.218	0.41	1.00	1.00	1.97	3.92	7.83	11.73	19.5	58.5	195.1
				IFOV [mm]		0.3	0.7	1.6	1.6	3.3	6.5	13.0	19.5	32.5	97.4	324.7

FOV = Field of view; HFOV = Horizontal field of view; VFOV = Vertical field of view; DFOV = Diagonal dimension of the total measuring field at the object level; IFOV = Indicated field of view
 Table with examples showing which measuring field sizes and pixel sizes are reached at which distance. Various lenses are available for optimal configuration of the camera. Wide angle lenses have radial distortion due to the angle of their aperture. The TIMConnect software has an algorithm which corrects this distortion.

* Please note: The measurement accuracy of the camera may lie outside of the specifications for distances below the defined minimum measurement distance.

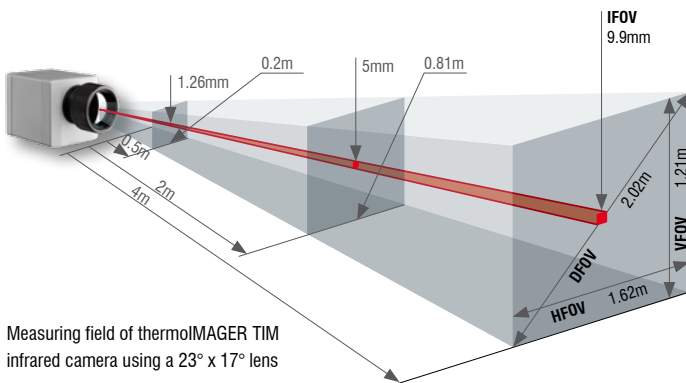

Measuring field of thermoIMAGER TIM infrared camera using a 23° x 17° lens

- Standard-, telephoto- and wide angle lenses for different applications
- High quality germanium lenses and special anti-reflective coating for excellent optics
- Factory-calibrated lenses for easy exchange of optical system without recalibration

Measuring field sizes can be calculated online at www.micro-epsilon.com/optikkalkulator.

TIM M1 with VGA resolution 764 x 480 px	Focal length [mm]	Angle	Minimum measurement distance*	Distance to measurement object [m]											
					0.1	0.2	0.3	0.5	1	2	4	6	10	30	100
f=16mm Wide angle lens	16	39° 25° 46° 0.94 mrad	0.2m	HFOV [m]		0.14	0.21	0.36	0.72	1.43	2.87	4.30	7.2	21.5	71.6
				VFOV [m]		0.09	0.14	0.23	0.45	0.90	1.80	2.70	4.5	13.5	45.0
				DFOV [m]		0.17	0.25	0.42	0.85	1.69	3.38	5.08	8.5	25.4	84.6
				IFOV [mm]		0.2	0.3	0.5	0.9	1.9	3.8	5.6	9.4	28.1	93.8
f=25mm Standard lens	25	26° 16° 30° 0.60 mrad	0.5m	HFOV [m]	0.046	0.09	0.14	0.23	0.46	0.92	1.83	2.75	4.6	13.8	45.8
				VFOV [m]	0.029	0.06	0.09	0.14	0.29	0.58	1.15	1.73	2.9	8.6	28.8
				DFOV [m]	0.054	0.11	0.16	0.27	0.54	1.08	2.17	3.25	5.4	16.2	54.1
				IFOV [mm]	0.1	0.1	0.2	0.3	0.6	1.2	2.4	3.6	6.0	18.0	60.0
f=50mm Telephoto lens	50	13° 8° 15° 0.30 mrad	1.5m	HFOV [m]				0.11	0.23	0.46	0.92	1.38	2.3	6.9	22.9
				VFOV [m]				0.07	0.14	0.29	0.58	0.86	1.4	4.3	14.4
				DFOV [m]				0.14	0.27	0.54	1.08	1.62	2.7	8.1	27.1
				IFOV [mm]				0.2	0.3	0.6	1.2	1.8	3.0	9.0	30.0
f=75mm Super telephoto lens	75	9° 5° 10° 0.20 mrad	2.0m	HFOV [m]					0.15	0.31	0.61	0.92	1.5	4.6	15.3
				VFOV [m]					0.10	0.19	0.38	0.58	1.0	2.9	9.6
				DFOV [m]					0.18	0.36	0.72	1.08	1.8	5.4	18.0
				IFOV [mm]					0.2	0.4	0.8	1.2	2.0	6.0	20.0

Please note: the camera provides 764 x 480 px in the 32Hz mode



MICRO-EPSILON Headquarters
Koenigbacher Str. 15 · 94496 Ortenburg / Germany
Tel. +49 (0) 8542 / 168-0 · Fax +49 (0) 8542 / 168-90
info@micro-epsilon.com · www.micro-epsilon.com

MICRO-EPSILON UK Ltd.
No.1 Shorelines Building · Shore Road · Birkenhead · CH41 1AU
Phone +44 (0) 151 355 6070 · Fax +44 (0) 151 355 6075
info@micro-epsilon.co.uk · www.micro-epsilon.co.uk