

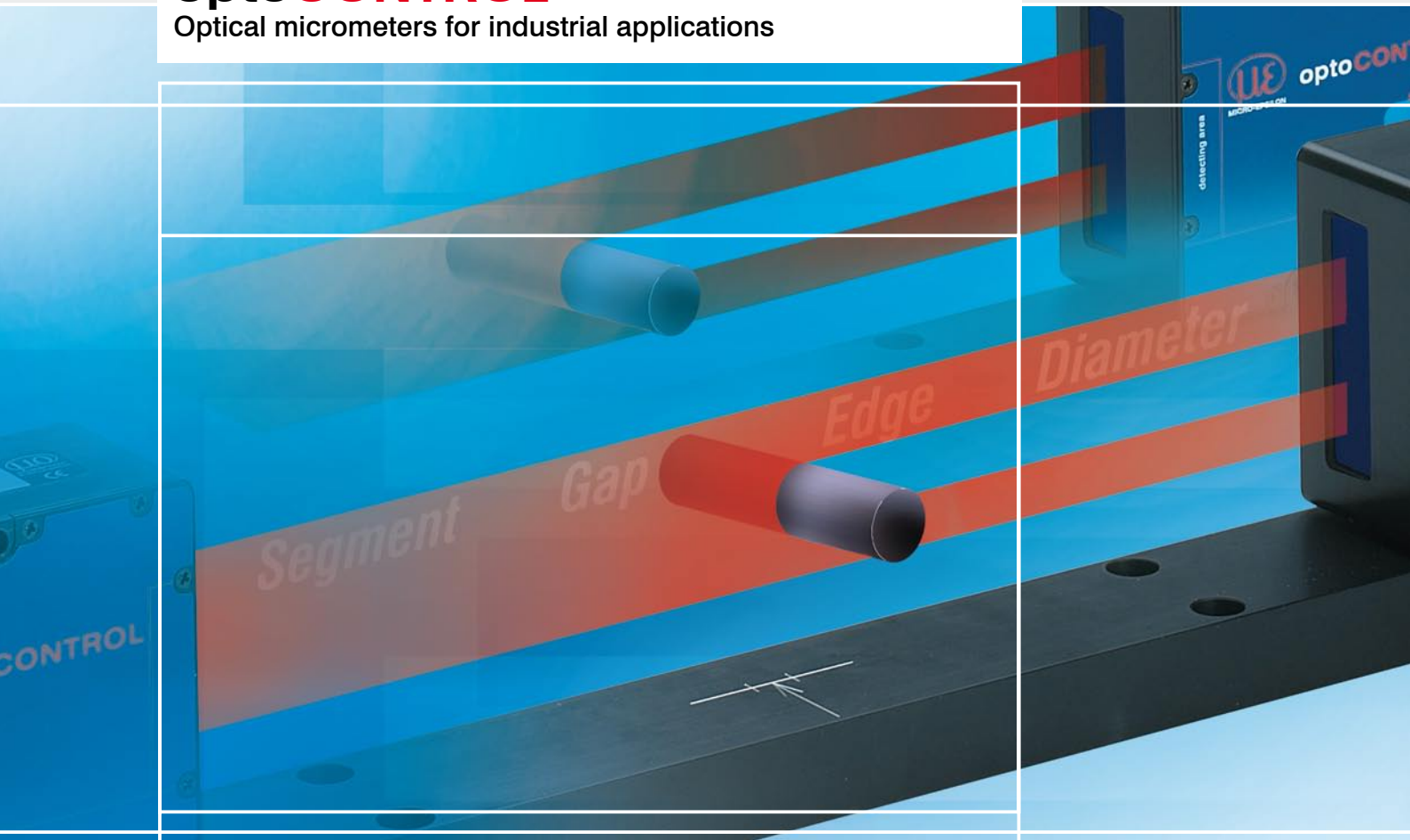

# More Precision.

## **optoCONTROL**

Optical micrometers for industrial applications



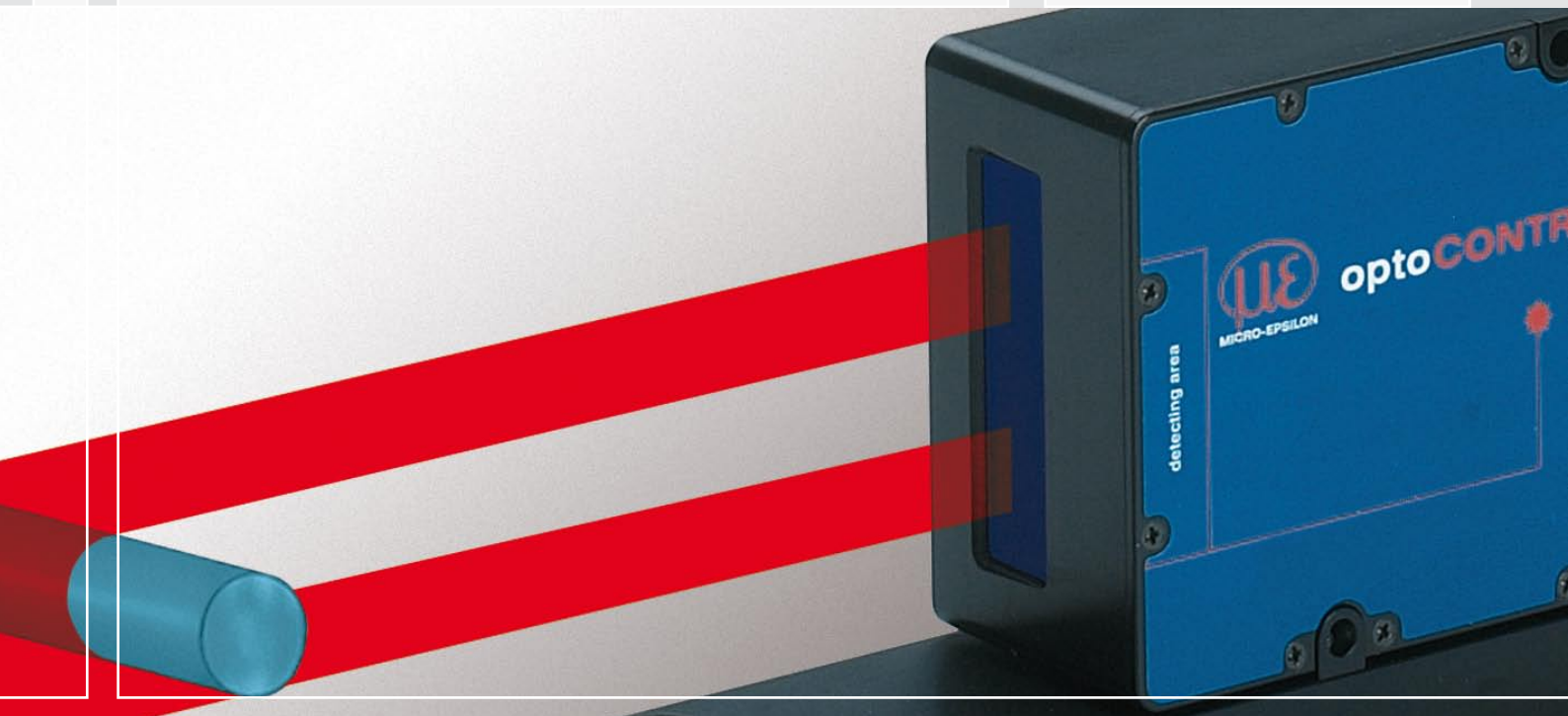

### Measuring principle

optoCONTROL 2600 is an optical measuring system with integrated high resolution CCD camera. Using a special lens arrangement, an LED light source produces a parallel light curtain (visible red light), which is imaged on the CCD camera via a telecentric lens. If an object to be measured is placed in the light curtain, the shadow it creates is detected by the CCD array. The measured data is output via analogue and digital interfaces.

### System design

optoCONTROL 2600 consists of a sensor unit and a controller, which are attached to a mounting rail. The sensor unit comprises a light source with high power LED and a receiver with telecentric lens and CCD array. The sensor unit is controlled and evaluated by an intelligent controller with graphical display for operation and display of the measured value. The adjustable light source enables precise measurement of most transparent objects. Significantly higher accuracies and repeatability of measured data is made possible due to the combination of LED with telecentric lens arrangement. The system is insensitive to high external light conditions.

### Predefined measurement modes (six individual programmes can be generated)

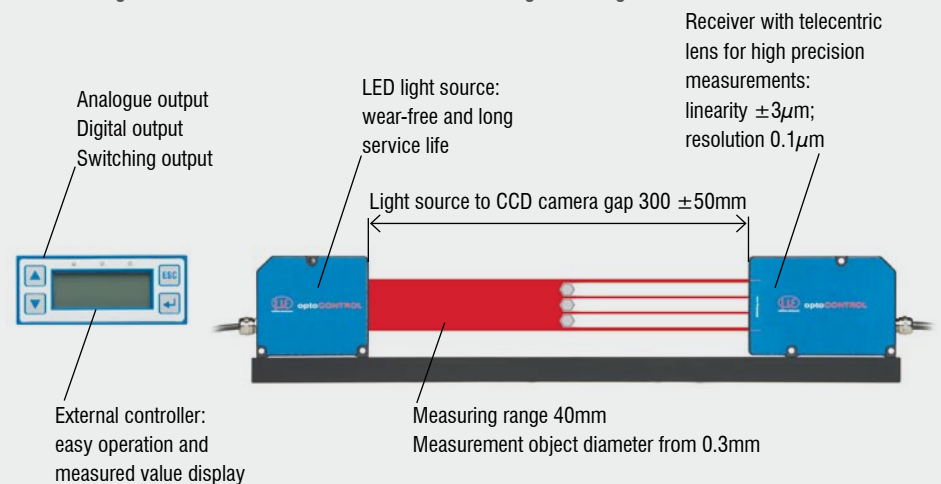
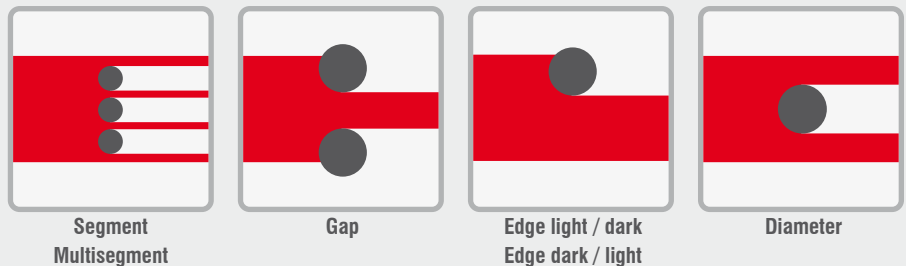

### Special features

- Maximum resolution and accuracy
- Outstanding repeatability
- Measuring rate 2.3kHz for fast processes
- High resistance to dirt and moisture
- Measurement against glass and transparent plastics
- Six different measuring programmes

Model	ODC2600-40	
Measuring range	40mm	
Smallest diameter (detectable target)	0.3mm	
Distance lightsource - CCD-camera	300 (±50)mm	
Distance (target to receiver)	150 (±5)mm	
Linearity (3s) <sup>1)</sup>	< ±3µm	
Resolution <sup>2)</sup>	0.1µm	
Repeatability	±1µm	
Sampling rate	2.3kHz	
Light source	red LED	
Analogue output (voltage)	0 ... 10VDC, range ±10VDC, selectable <sup>3)</sup>	
Digital output	RS232 (115.2kBaud) or RS422 (691.2kBaud)	
Switching output	error, 4x limit, synchronisation	
Input	zero; reset; trigger; synchronisation; light on/off (programmable)	
Operation temperature	0°C to 50°C	
Storage temperature	-20°C to 70°C	
Supply voltage	24VDC (±15%), < 1A	
Vibration	acc. IEC 60068-2-6 2g / 20 ... 500Hz	
Shock	acc. IEC 60068-2-29 15g / 6ms	
Cable length (controller-transmitter / controller-CCD-camera)	Standard: 2m	
Protection class	receiver / light source	IP 64
	controller	IP 40
Measuring programmes	edge light-dark; edge dark-light; diameter; gap; segment; multi-segments; 4 user-programs	
Display	LC-display (value, maximum, minimum, peak-to-peak); display in mm or inch, selectable; menu languages in german / english, selectable; 3x LED (power on, light on, error)	

All specifications are measured at a constant temperature of 20°C after a warm-up time of 30 minutes.

<sup>1)</sup> Edge measurement at 2.3kHz, no averaging at the target, operating distance 150 ±5mm.

<sup>2)</sup> Display resolution (resolution digital output 0.6µm)

<sup>3)</sup> The gain of the analogue output can be increased to a max. of 10V / 10mm respectively 10V / 20mm (analogue gain 4) then 0.3µm resolution.

#### Optional versions

- Carry case version for service tasks
- Customised cable lengths, modified cable outlet
- Customer-specific software (measuring programmes, statistics)
- Version with deflection mirror for installation in restricted spaces

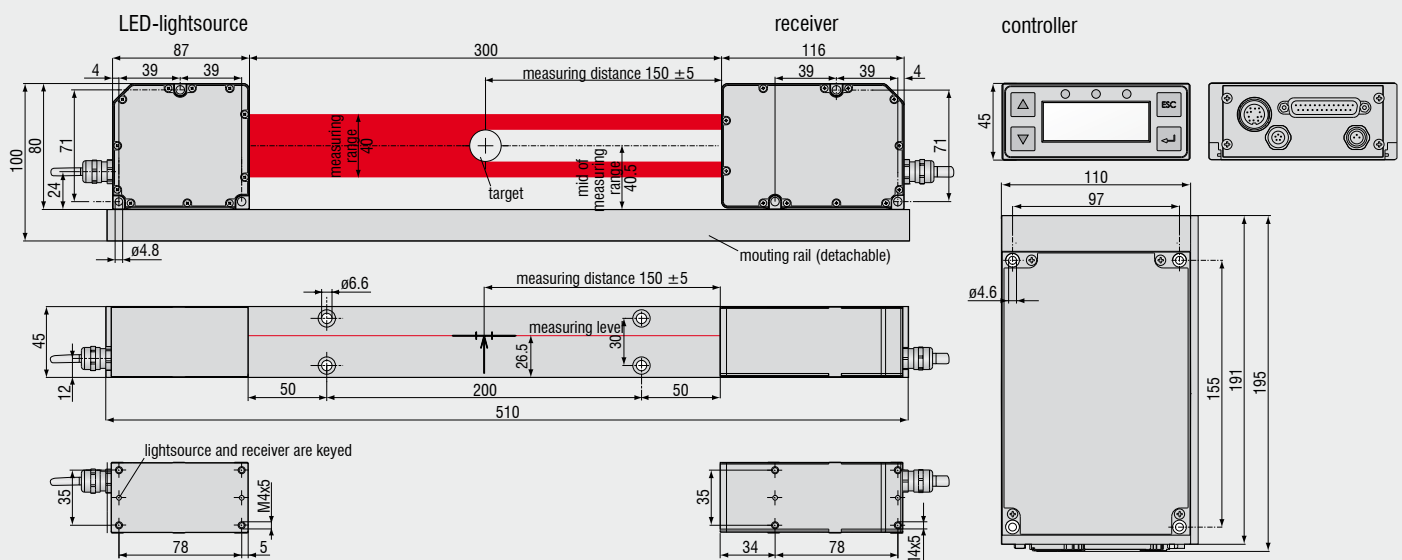

### Measurements with several micrometers

- Thickness measurement
- Level measurement
- Width measurements
- Planarity measurements
- Edge determination
- Diameter measurement

#### Interface card IF 2008 for synchronous data recording

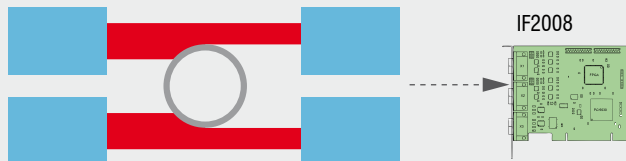

Up to six digital signals, two analogue signals, two encoders

The IF 2008 interface card is designed for installation in PCs and enables the synchronous capture of up to six digital sensor signals, two analogue sensor signals and two encoders. The card is used for the customer's own data evaluation. The interface card reads the data from all connected devices simultaneously and transmits these to an external PC for further processing.

#### CSP 2008: universal controller for multiple sensor signals

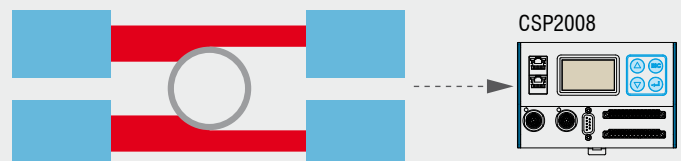

Two to six analogue or digital signals

The CSP2008 controller is used for processing at least two, maximum of six digital or analogue input signals (2 x internal + 4 x external via EtherCAT modules from Beckhoff). EtherCAT is also envisaged as the external interface for connecting further sensors and I/O modules. The controller has a display with multi-coloured backlighting, which changes colour when pre-set limits have been exceeded or alarms have been programmed.

Calculation:

A,B; A+B; A-B; -A-B; K-A-B; K+A+B;  
K+A-B; K+A; K+B; K(A+B); K(A+k\*B)

#### Accessories for optoCONTROL 1200/1201/1202

Art. No.	Modell	
2901260	PC1200-5	Power supply and signal cable 5m, straight connector, for light source and receiver unit
2901261	PC1200/90-5	Power supply and signal cable 5m, angled connector, for light source and receiver unit
2420019	PS2010	Power supply for DIN rail mounting, input 230VAC, output 24V DC/2.5 A
2901497	CE1202-2	Connecting cable transmitter-receiver, 2m
2901482	CE1202-5	Connecting cable transmitter-receiver, 5m
2901371	SCD1202-2	Digital output cable, 2m, for connection to a RS232 port
2901509	SCD1202-5	Digital output cable, 5m, for connection to a RS232 port
2901373	SCA1202-2	Power supply and analogue output cable, 2m
2901510	SCA1202-5	Power supply and analogue output cable, 5m

#### Accessories for optoCONTROL 2500/2600

2420057	CSP2008	Universal controller for multiple signals
2213017	IF2008	PCI interface card RS422
2901057	CE1800-3	Sensor cable extension for camera, 3m
2901118	CE2500-3	Sensor cable extension for light source, 3m
2901058	CE1800-8	Sensor cable extension for camera, 8m
2901119	CE2500-8	Sensor cable extension for light source, 8m
2901120	SCA2500-3	3 Signal output cable, analogue, 3m
2901121	SCD2500-3/3/RS232	Signal output cable 3m, for RS232
2901122	SCD2500-3/10/RS422	Signal output cable 3m / RS422 10m
2901123	PC2500-3	Power supply cable 3m
2901124	PC2500-10	Power supply cable 10m
2901504	SCD2500-3/CSP	Power supply and output cable 3m, for connection to CSP2008
2901505	SCD2500-10/CSP	Power supply and output cable 10m, for connection to CSP2008
2901122	SCD2500-3/10/RS422	Output cable with RS422, 3 or 10m, for connection to IF2008