

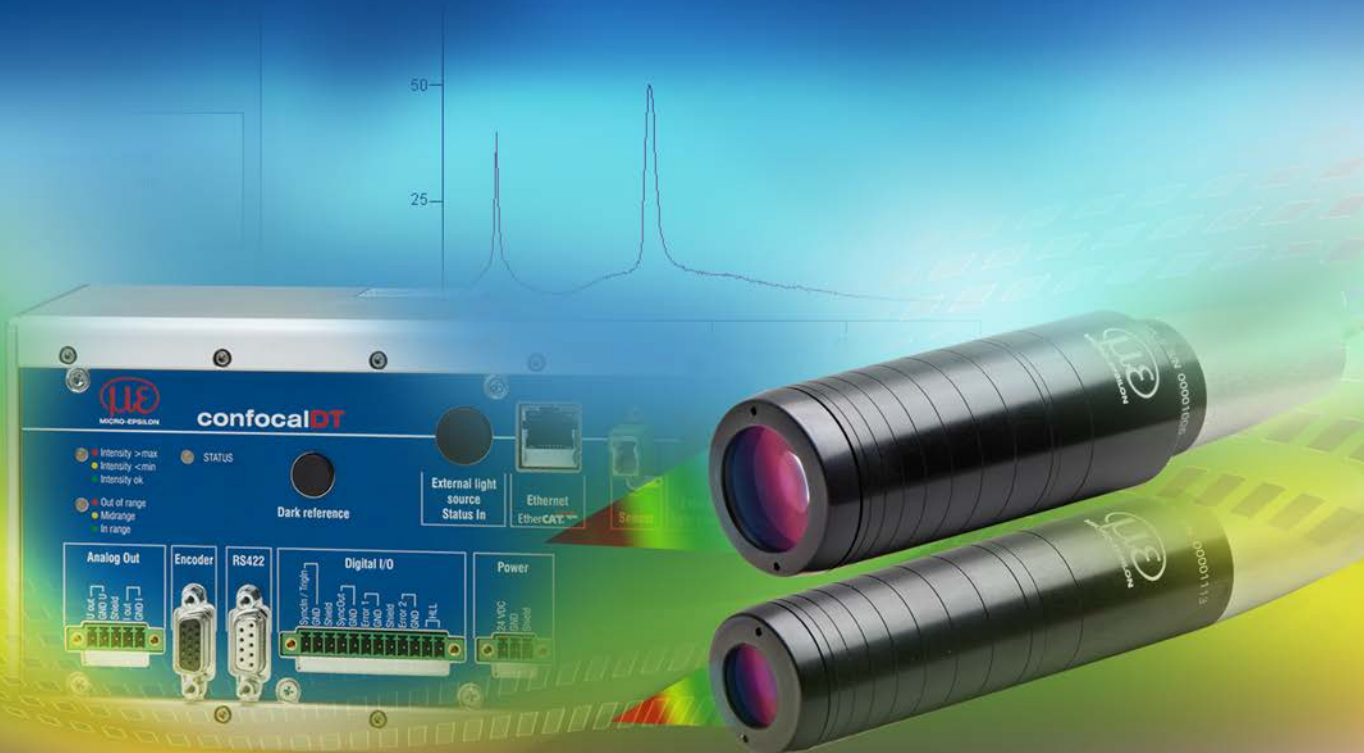







# More Precision

**confocalDT** // Confocal chromatic measurement system





-  **Robust sensors for various applications**
-  **One-sided thickness measurement of transparent material**
-  **Displacement and position measurement**
-  **Tiny spot size**
-  **Submicrometer resolution**
-  **Passive design without electronic components**

The confocal sensors in the IFS2405 series are designed for measurement tasks that require maximum precision. These new sensors excel through their high sensitivity. The high tilt angle and the relatively large base distance enable a great variety of potential applications. As well as distance measurements for reflective and transparent surfaces, the sensor can also be used for one-sided thickness measurement of clear film, boards or layers.

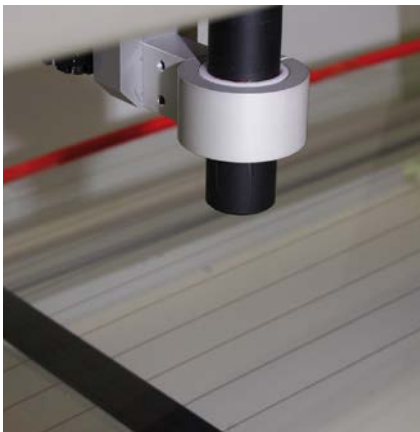

Thickness measurement of rear windows

IFS2405-0.3

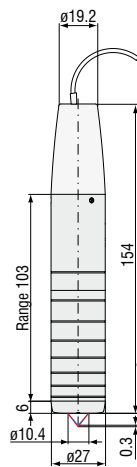

IFS2405-1

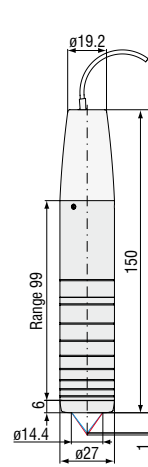

IFS2405-3

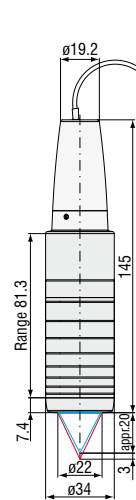

IFS2405-10

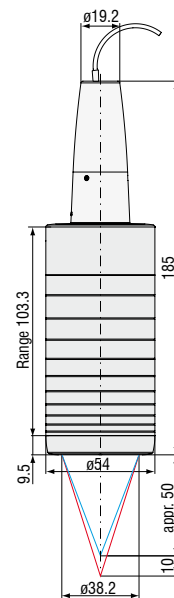

IFS2405-30

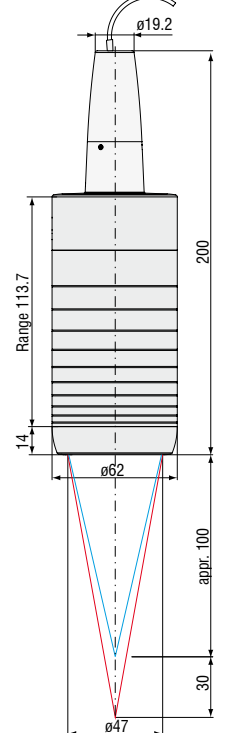

IFS2405-28

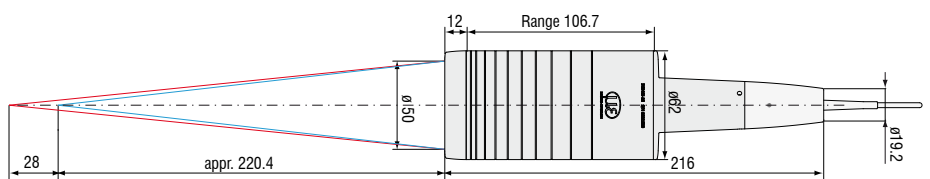

Sensor model	IFS 2405-0,3	IFS 2405-1	IFS 2405-3	IFS 2405-10	IFS 2405-28	IFS 2405-30
Measuring range	0.3mm	1mm	3mm	10mm	28mm	30mm
Start of measuring range	appr. 6mm	10mm	20mm	50mm	220mm	100mm
Spot diameter	6 $\mu$ m	8 $\mu$ m	9 $\mu$ m	16 $\mu$ m	60 $\mu$ m	50 $\mu$ m
Linearity (displacement measurement)	0.15 $\mu$ m	0.25 $\mu$ m	0.75 $\mu$ m	2.5 $\mu$ m	7 $\mu$ m	7.5 $\mu$ m
	±0.05 % FSO		±0.025 % FSO			
Linearity (thickness measurement)	0.3 $\mu$ m	0.5 $\mu$ m	1.5 $\mu$ m	5 $\mu$ m	14 $\mu$ m	15 $\mu$ m
	±0.1 % FSO		±0.05 % FSO			
Resolution <sup>1)</sup>	10nm	28nm	36nm	60nm	250nm	180nm
Weight	140g	125g	225g	500g	750g	730g
Max. tilt <sup>2)</sup>	±34°	±30°	±24°	±17°	±5°	±9°
Protection class	IP 65, front					
Operation temperature	+5 ... +70 °C					
Storage temperature	-20°C ... +70°C					
Sensor cable (fibre optic cable)	length: standard 3m; option up to 50m; bending radius: static 30mm; dynamic 40mm					
Shock	15g, 6ms					
Vibration	2g / 10Hz ... 500Hz					

FSO = Full Scale Output

All data at constant ambient temperature (25±2°C) against optical flat; specifications can change when measuring different materials.

<sup>1)</sup> Average from 512 values at 1kHz, near to the centre of the measuring range

<sup>2)</sup> Maximum sensor tilt angle that produces a usable signal, near to the centre of the measuring range

#### Accessories: mounting adapter

MA2400 for sensors 2405 (consisting of a mounting block and a mounting ring)

mounting block

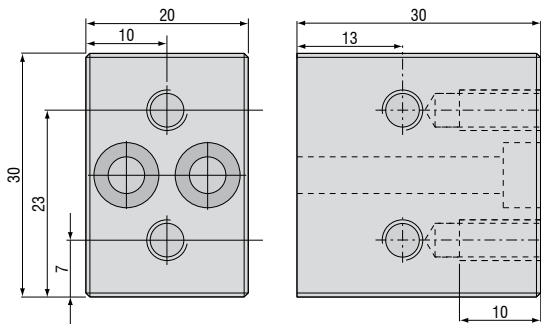

mounting ring

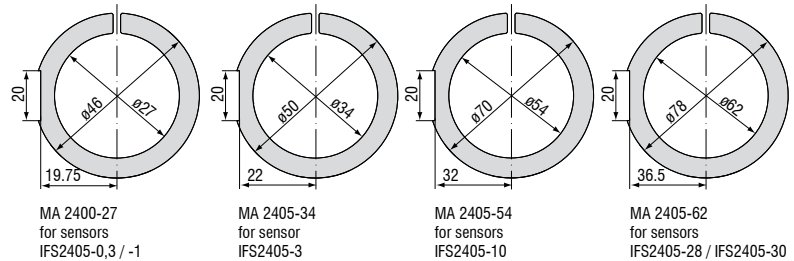

## Accessories

### Software

IFD24n1-Tool Free demo software tool included in delivery

### Accessories light source

IFX2471/Xe/75 external Xenon light source for controller IFC2471 (70 kHz)  
 IFX2471/Xe/75-light-bulb for IFX2471  
 IFL2451/LED-light-bulb for IFC2451  
 IFL2451/LED(003)-light-bulb for IFC2451(003) with cooling element  
 CL2471-1/Xe Light source cable, 1m

### Accessories IFS2405

C2401-X Fibre optical cable (3m, 10m, customer specific length up to 50m)  
 C2401/PT-X Armored cable (3m, 10m, customer specific length up to 50m)  
 C2401-3(10) Sensor cable for drag chain use, 3m  
 C2401-5(10) Sensor cable for drag chain use, 5m

### Accessories IFS2402/2403

CE2402-X Extension for fibre optical cable (3/10/13/30/50m)  
 CE2402-X/PT Sensor with armored cable  
 (3/10m, customer specific length up to 50m)  
 C2402/Vac/KF16 Vacuum feedthrough, 1 channel  
 C2405/Vac/6/CF63 Vacuum feedthrough, 6 channel  
 C2405/Vac/9/CF63 Vacuum feedthrough, 9 channel

### Accessories

SC2471-3/USB/IND Connector cable IFC2451/61/71, 3m  
 SC2471-3/IF2008 Connector cable IFC2451/61/71-IF2008, 3m  
 SC2471-3/CSP Connector cable IFC2451/61/71-CSP2008, 3m  
 SC2471-10/IF2008 Connector cable IFC2451/61/71-IF2008, 10m  
 SC2471-10/CSP Connector cable IFC2451/61/71-CSP2008, 10m  
 SC2471-10/USB/IND Connector cable IFC2451/61/71, 10m  
 SC2471-20/USB/IND Connector cable IFC2451/61/71, 20m  
 PS2020 Power supply 24 V / 2,5 A  
 EC2471-3/OE Encoder cable, 3 m

### Fibre optic

Temperature range : -50°C - 90°C

Bending radius: 30/40mm

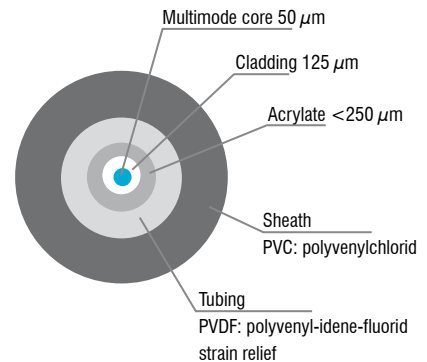

### E2000/APC standard connector

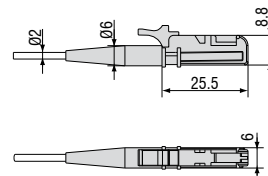

## High performance sensors made by Micro-Epsilon



Sensors and systems for displacement and position



Sensors and measurement devices for non-contact temperature measurement



2D/3D profile sensors (laser scanner)



Optical micrometers, fibre optic sensors and fibre optics



Colour recognition sensors, LED analyzers and colour online spectrometer



Measurement and inspection systems



MICRO-EPSILON Headquarters  
Koenigbacher Str. 15 · 94496 Ortenburg / Germany  
Tel. +49 (0) 8542 / 168-0 · Fax +49 (0) 8542 / 168-90  
info@micro-epsilon.com · [www.micro-epsilon.com](http://www.micro-epsilon.com)

MICRO-EPSILON UK Ltd.  
No.1 Shorelines Building · Shore Road · Birkenhead · CH41 1AU  
Phone +44 (0) 151 355 6070 · Fax +44 (0) 151 355 6075  
info@micro-epsilon.co.uk · [www.micro-epsilon.co.uk](http://www.micro-epsilon.co.uk)