



More Precision

capa**NCDT** // Capacitive displacement sensors and systems





- Compact and robust construction
- High temperature stability
- Nanometre repeatability
- Suitable for all conductive materials
- 24V (9 – 36V) standard power supply for industrial applications
- Ideal for OEM applications
- Suitable for practically all sensors

System construction

The capaNCDT 6110 single channel capacitive electronics is an extremely compact and low cost controller, compatible with all Micro Epsilon capacitive sensor ranges. Designed to be robust and simple to use, it is ideally suited to integration into OEM applications and simple single channel end user requirements. With all items available from stock, the user can quickly select the most suitable sensor range and cable length to be used with the capaNCDT 6110 electronics. For higher volume applications, the capaNCDT 6110 can be used as a base specification for modification to user specific requirements.

The flexible 9-36V DC power supply, enables the capaNCDT 6110 series to also be used in mobile applications. Measurement output values are selectable 0-10V or +/-5V DC and high temperature stability and resolutions are achieved.

A measuring system consists of:

- Capacitive displacement sensor
- Sensor cable
- Controller
- Supply and signal output cable

Accessory:

- Power supply

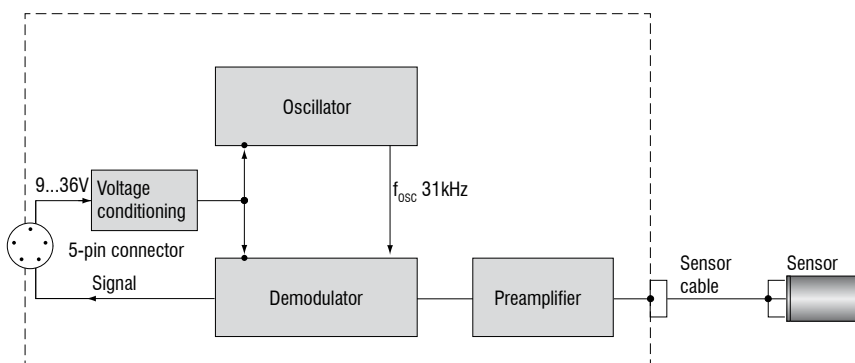

Controller type		DT6110	DT6110/ECL2
Resolution static		0.01 % FSO	0.01 % FSO
Resolution dynamic		0.015 % FSO (1kHz)	0.015 % FSO (1kHz)
Bandwidth		1 kHz (-3dB)	1 kHz (-3dB)
Linearity (typ.)		±0.05% FSO	±0.05% FSO
Max. sensitivity deviation		±0.1% FSO	±0.1% FSO
Long term stability		<0.05% FSO/month	<0.05% FSO/month
Synchronous operation		no	no
Insulator measurement		no	no
Temperature stability		200ppm	200ppm
Temperature range (operation)	Sensor	-50 ... + 200 °C	-50 ... + 200 °C
	Controller	+ 10 ... + 60°C	+ 10 ... + 60°C
Temperatur range (storage)		-10 ... +75°C	-10 ... +75°C
Supply		24VDC/55mA (9 ... 36V)	24VDC/55mA (9 ... 36V)
Output		0 ... 10V (short-circuit-proof), optional: ±5V, 10 ... 0V	0 ... 10V (short-circuit-proof), optional: ±5V, 10 ... 0V
Sensors		suitable for all sensors	suitable for all sensors
Sensor cable		CC cable ≤ 1m CCm cable = 1.4m CCg cable = 2m	CC cable ≤ 2m CCm cable = 2.8m CCg cable = 4m

FSO = Full Scale Output

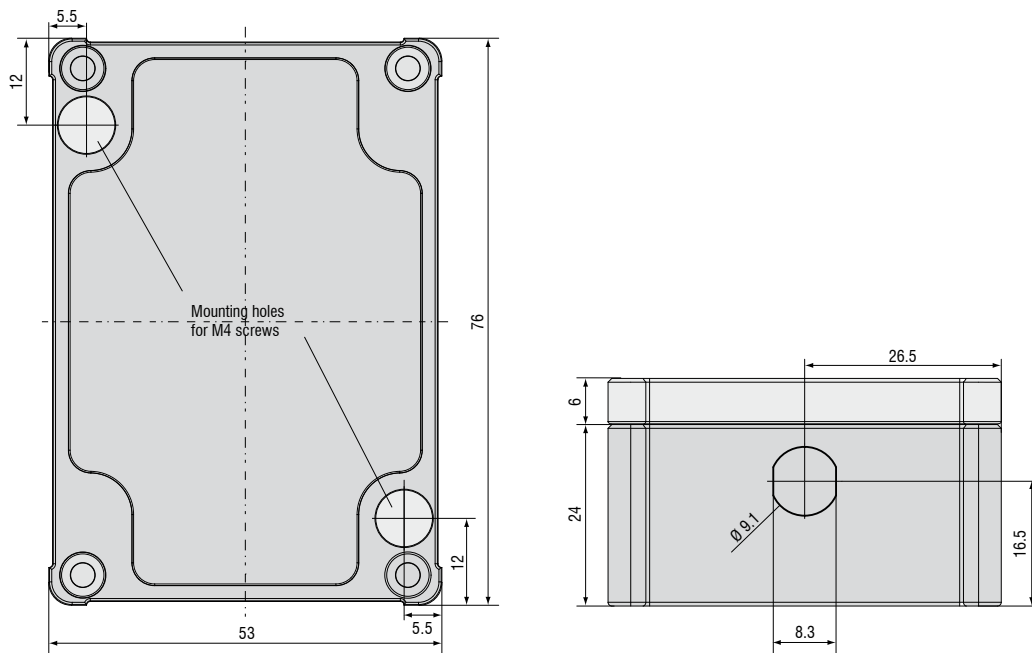

Sensor cable	Cable CCx,x / CCx,x/90	Cable CCmx,x / CCmx,x/90	Cable CCgx,x / CCgx,x/90
Description	Low-outgassing cable up to 4m length, for applications in clean rooms	Low-outgassing cable up to 4.2m length, for applications in clean rooms, UHV and EUV	Robust cable up to 8m length, for industrial applications
Temperature stability	-100°C to +200°C	-100°C to +200°C	-20°C to +80°C (permanent) -20°C to +100°C (10,000 h)
Outer diameter	3.1mm ±0.1mm	2.1mm ±0.1mm	3.1mm ±0.1mm
Bending radius	3x cable diameter during installation; 7x cable diameter for movement; 12x cable diameter recommend at continuous movement		

Version	Cable with connector type C for sensors CS005 / CS02 / CS05 / CSE05 / CS08 / CSE1						Cable with connector type B for sensors CS1 / CS1HP / CS2 / CSE2 / CS3 / CS5 / CS10					
	2 x straight connector			1 x straight / 1 x 90° connector			2 x straight connector			1 x straight / 1 x 90° connector		
Type	CCx,xC	CCmx,xC	CCgx,xC	CCx,xC/90	CCmx,xC/90	CCgx,xC/90	CCx,xB	CCmx,xB	CCgx,xB	CCx,xB/90	CCmx,xB/90	CCgx,xB/90
Standard 1m	•		•	•		•	•		•	•		•
1.4m		•			•			•			•	
2m	•		•	•		•	•		•	•		•
2.8m		•			•			•			•	
3m	•			•			•			•		
4m			•			•			•			•
4.2m		•			•			•			•	
6m			•			•			•			•
8m			•			•			•			•

Sensor cable with connector type C

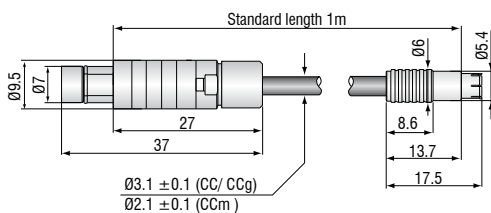

Connector type C/90

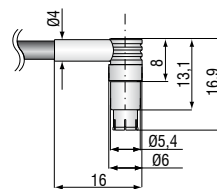

Sensor cable with connector type B

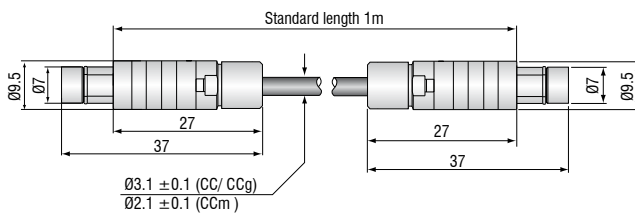

Connector type B/90

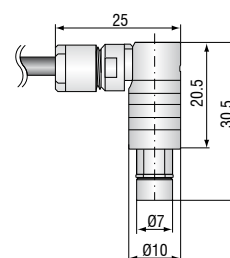

Accessories	capaNCDT	6110	6200	6500
MC2.5 Micrometer for sensor calibration, range 0 - 2.5mm, Resolution 0.1µm. Suitable for sensors CS005 to CS2		•	•	•
MC25D Digital micrometer for sensor calibration, range 0 - 25mm, adjustable offset (zero). Suitable for all sensors.		•	•	•
HV/B Vacuum feed through triaxial		•	•	•
UHV/B Vacuum feed through triaxial for ultra-high vacuum		•	•	•
PC6200-3/4 Power-/trigger cable, 4 pin, 3m			•	
SCAC3/4 Signal output cable, (necessary for multi channel applications), 4 pin, 3m			•	
SCAC3/5 Signal output cable, analog, 5 pin, 3m		•		
SC6000-1,0 Synchronization cable, 5 pin, 1m			•	•
CA5 Preamplifier cable 5 pin, 5m				•
PS2020 Power supply for DIN rail mounting; Input 230VAC (115VAC); Output 24VDC / 2.5 A; L/W/H 120x120x40mm		•	•	

HV/B Vacuum feed through (Art.-no. 0323050)

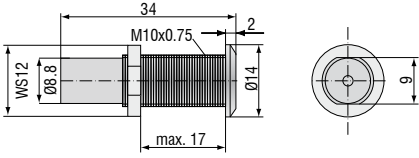

Max. leak rate 1×10^{-7} mbar · l s⁻¹, compatible with connector type B

UHV/B Vacuum feed triax weldable (Art.-no. 0323346)

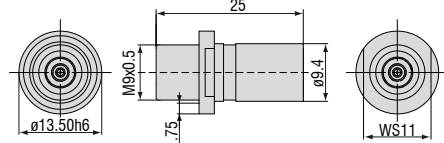

Max. leak rate 1×10^{-9} mbar · l s⁻¹, compatible with connector type B

UHV/B Vacuum feed triax with flange CF16 (Art.-no. 0323349)

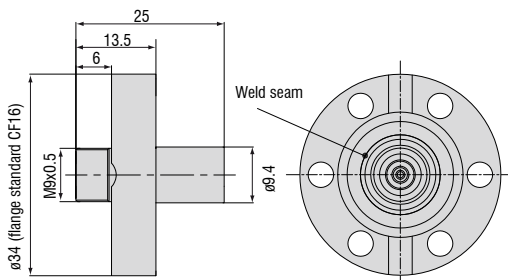

Max. leak rate 1×10^{-9} mbar · l s⁻¹, compatible with connector type B

UHV/B Vacuum feed triax screwable (Art.-no. 0323370)

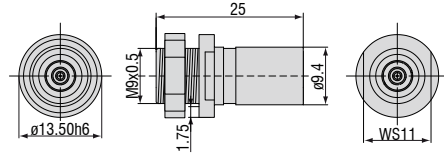

Max. leak rate 1×10^{-9} mbar · l s⁻¹, compatible with connector type B

SCA3/4 Signal output cable (Art.-no. 2902104)

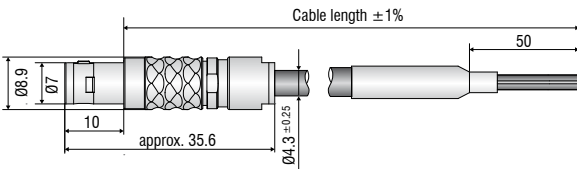

SCA3/5 Signal output cable (Art.-no. 2902112)

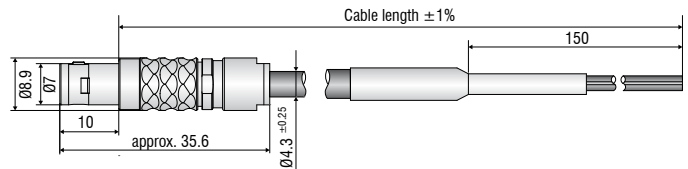

PC6200-3/4 Power-/trigger cable (Art.-no. 2901881)

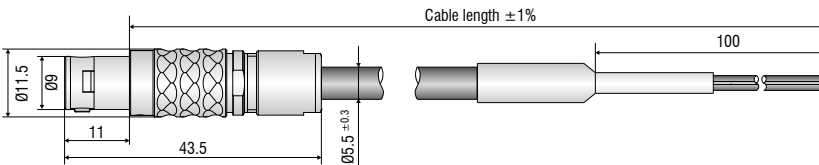

SC6000-1,0 Synchronization cable (Art.-no. 2903473)

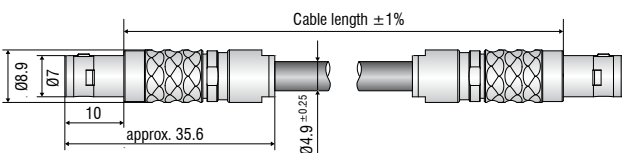

CA5 Preamplifier cable (Art.-no. 2903180)

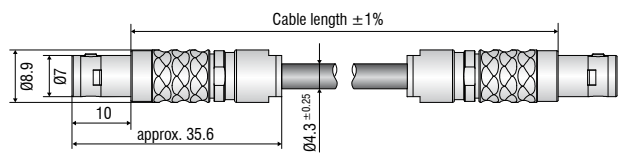

High performance sensors made by Micro-Epsilon



Sensors and systems for displacement and position



Sensors and measurement devices for non-contact temperature measurement



2D/3D profile sensors (laser scanner)



Optical micrometers, fibre optic sensors and fibre optics



Colour recognition sensors, LED analyzers and colour online spectrometer



Measurement and inspection systems

