











Laser Triangulation Displacement Sensors





-  **Laser line averages across shiny metallic or structured surfaces**
-  **Four models with measuring ranges from 2mm to 50mm**
-  **Sensor head and separate controller**
-  **Measurement rate up to 20kHz**
-  **RTSC Real Time Surface Compensation**
-  **Analogue and digital output**
-  **Adjustable filter functions (firmware)**
-  **Calibration certificate included**
-  **Configuration via software www.micro-epsilon.com/download**

The optoNCDT 2200LL series uses a small laser line, instead of a spot, to provide accurate measurement against shiny metallic surfaces. The use of the laser line allows the sensor to perform an average across the line. This makes it possible to measure rough surfaces with greater accuracy than before. The sensor can also be used for measuring directly reflecting surfaces without the need to angle the sensor.

The optoNCDT 2220LL series uses a small laser line, instead of a spot, to provide accurate measurement against shiny metallic surfaces all at high speed.

optoNCDT 2200LL (2/10/20/50mm)
optoNCDT 2220LL (2/10/20/50mm)

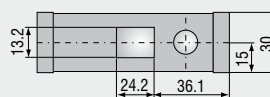
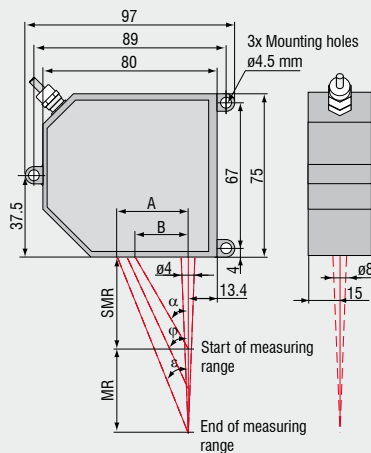

(Dimensions in mm, not to scale.
All CAD files are available online.)

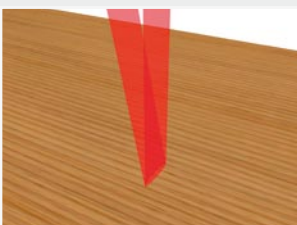

Controller

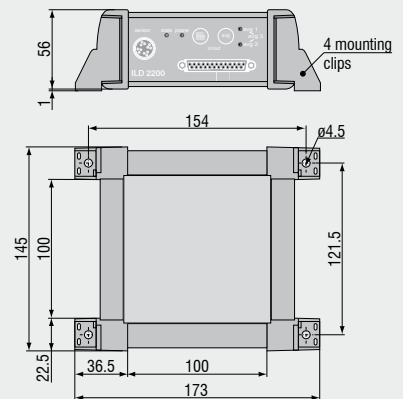

MR	SMR	α	ϕ	ϵ	A	B
2	24	35.0°	40.0°	44.8°	25.8	16.8
10	30	34.3°	35.2°	35.6°	28.7	20.5
20	40	28.8°	27.5°	26.7°	30.1	22
50	45	26.5°	23.0°	18.3°	31.5	22.5

Model		ILD 2200-2LL ILD 2220-2LL	ILD 2200-10LL ILD 2220-10LL	ILD 2200-20LL ILD 2220-20LL	ILD 2200-50LL ILD 2220-50LL
Measuring range		2mm	10mm	20mm	50mm
Start of measuring range		24mm	30mm	40mm	45mm
Midrange		25mm	35mm	50mm	70mm
End of measuring range		26mm	40mm	60mm	95mm
Linearity		1µm ≤0.05% FSO	3µm	6µm ≤0.03% FSO	15µm
Resolution ^{1) 2)} (without averaging)		0.03µm	0.15µm	0.3µm	0.8µm
			0.0015% FSO		
Measuring rate	ILD 2200	10kHz			
	ILD 2220	20kHz			
Permissible ambient light		30,000lx			
Spot diameter	SMR	85 x 240µm	120 x 405µm	185 x 485µm	350 x 320µm
	MMR	24 x 280µm	35 x 585µm	55 x 700µm	70 x 960µm
	EMR	64 x 400µm	125 x 835µm	195 x 1200µm	300 x 1940µm
Light source		semiconductor laser <1mW, 670nm (red)			
Laser safety class		class 2 IEC 60825-1 : 2008-05			
Protection class		sensor: IP 65 / controller: IP 50			
Temperature stability		0.025% FSO/°C	0.01 % FSO/°C		
Operation temperature		0 ... +50°C			
Storage temperature		-20 ... +70°C			
Output		analogue: ±5V digital: RS 422 / 691.2kBaud			
Power supply		24VDC (±15%), max. 500mA			
Sensor cable length		standard: 2m - integrated option: 5m/10m			
Controller		functions: auto zero / signal averaging dimensions: 143mm x 145mm x 52mm - without mounting clips			
Electromagnetic compatibility (EMC)		EN 55011/12.1998 and EN 50082-2/02.1996			
Vibration		2g / 20 ... 500Hz			
Shock		15g / 6ms / 3 axis			
Weight		sensor: ~550g controller: ~1000g			

FSO = Full Scale Output SMR = Start of measuring range MMR = Midrange EMR = End of measuring range

All specifications apply for a diffusely reflecting white ceramic target

¹⁾ for measurements against high glossy surfaces (targets), resolution depends on the material

²⁾ resolution digital output 16bit

Custom Sensor Modifications

For applications where the above standard sensors do not meet your requirements, it may be possible to supply a sensor with modified specification. Please contact us for further information.

Options

- Non standard measuring range and stand off
- Custom housing or mounting geometry
- Measuring rate 2.5 / 5 / 10 / 20kHz
- Non standard signal interfaces
- Special cable length of electrical connector
- 90° beam deflection
- Vacuum suitability
- Reduced mass
- Increased shock and vibration resistance

Accessories for all optoNCDT SeriesPower supply

PS 2020 (Power Supply 24 V / 2,5 A, Input 100 - 240 VAC, output 24 VDC / 2.5 A, for snap in mounting on DIN 50022 rail)

Controller

CSP 2008 (controller for processing of multiple sensor signals; analogue and digital interfaces)

Interface card

IF2008 (Interface card for individual signal processing; analogue and digital interfaces)

Accessories optoNCDT 1302 / 1402Supply and output cable, rated for moving cable tracks (also available in 90° version)

PC 1402-3/I (3m, output 4 ... 20mA)

PC 1402-6/I (6m, output 4 ... 20mA)

PC 1402-3/U (3m, with integral resistance, output 1 ... 5VDC)

PC 1402-6/U (6m, with integral resistance, output 1 ... 5VDC)

PC1402-3/IF2008 (3m, supply and output cable)

PC 1402-3/USB (3m, supply and output cable)

PC1401/1402-0.2 (0.2m, adapter cable 12-pin to 7-pin)

PC 1402-3/CSP (3m, required for CSP 2008, optoNCDT 1402 only)

Supply and output cable, robot rated

(available in 90° version)

PCR 1402-3/I (3m)

PCR 1402-6/I (6m)

PCR 1402-8/I (8m)

Protective housing

SGH 1800

SGHF 1800

Accessories optoNCDT 1607 / 1627Supply and output cable

PC 1605-3 (3m)

PC 1605-6 (6m)

PC 1607-3/RS232 (3m, with 9-pin Sub-D connector for RS232)

Protective housing

SGF 1605-20 (for LD1607-2/4/10/20)

SGF 1605-200 (for LD1607-50/100/200)

SGL with connection for compressed air

Accessories**optoNCDT 1700/1700LL**Supply and output cable

(drag chain rated)

PC 1700-3 (3m)

PC 1700-10 (10m)

PC 1700-10/3/IF2008 (10m, for use with interface card IF2008)

PC 1700-3/T (3m, for use with trigger box)

PC 1700-10/T

(10m, for use with trigger box)

PC 1700-3/USB (3m, with USB-RS422-converter, power supply 90 ... 230 VAC)

Supply and output cable (robot rated)

PCR 1700-5 (5m)

PCR 1700-10 (10m)

Protective housing

SGH 1800

(for ILD 1700-2/10/20/50/100/200/250VT and ILD 1700-2LL/10LL/20LL/50LL)

SGH 2200-200 (for ILD 1700-40/500/750)

SGxF 1800

(option with compressed air clean setup)

SGxF 2200-200

(option with compressed air clean setup)

External trigger

Triggerbox 1700 (Electronics for triggering optoNCDT 1700 sensors. Acceptable trigger levels from +2.4VDC to +24VDC, L/W/H 98x64x34mm)

Accessories**optoNCDT 2200(LL) / 2220(LL) /****1710-50 / 2210**Supply and output cable (drag chain rated)

PC 1800-3 (3m)

PC 1800-8 (8m)

PC2200-3/10/RS485 (3m, RS 485 for use with interface card IF2008)

PC 2200-3/3/RS422 (3m, for IF2008/RS422/USB-converter)

Sensor cable extension (drag chain rated)

CE 1800-3 (3m)

CE 1800-8 (8m)

Protective housing

(only for series 2200, 2200LL, 2220, 2220LL)

SGx 1800 (for ILD 2200-2/10/20/50/100,

ILD 2200-2LL/10LL/20LL/50LL,

ILD 2220-2/10/20/50/100,

ILD 2220-2LL/10LL/20LL/50LL)

SGH 2200-200

(for ILD 2200-40/200, ILD 2220-200)

SGxF 1800 (option with compressed air clean setup)

SGxF 2200-200 (option with compressed air clean setup)

Accessories optoNCDT 2300Supply and output cable

PC2300-0,5Y (Connecting cable to PC or SPS; for operation a PC2300-3/SUB-D will be required)

PC2300-3/SUB-D (3m; for operation a PC2300-0,5Y will be required)

PC2300-3/CSP (3m, connecting cable ILD2300 and CSP2008)

PC2300-10/CSP (10m, connecting cable ILD2300 and CSP2008)

PC2300-15/CSP (15m, connecting cable ILD2300 and CSP2008)

PC2300-3/IF2008 (3m, interface and supply cable)

PC2300-3/OE (3m)

PC2300-6/OE (6m)

PC2300-9/OE (9m)

PC2300-15/OE (15m)

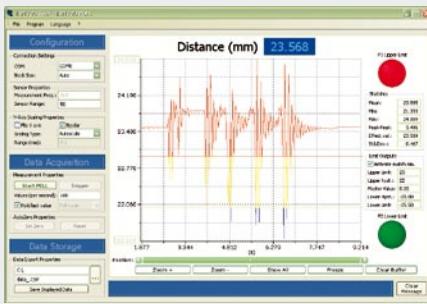

Setup and configuration software

ILD Tools is the software included for easy sensor configuration. All the settings can be implemented conveniently via a Windows user interface on the PC. The sensor parameters are sent to the sensor via the serial port and can also be saved if required. ILD Tools also includes a module which can display and save measurement results. The link to the PC is made via the sensor cable with a USB converter. [available for all series except 1302 and 1607]

Driver support for customer software

For the optNCDT sensors documented DLL drivers are available free of charge, which enables easy integration of the sensors into existing software.

Software download free of charge from
www.micro-epsilon.com/download

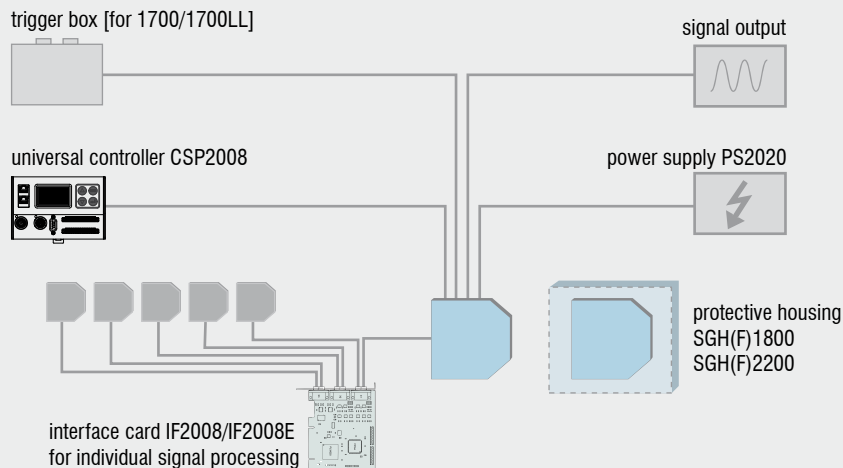

Protective housing for harsh environment

To protect the laser sensors in extreme environments individual protective housings are available for all sensor models. Three options for the protective housing are offered.

Option SGH:

Completely enclosed housing with an integrated front window, where the sensor measures through the window. The water resistant housing (IP68) provides protection against aggressive solvents and detergents.

Option SGHF:

The SGHF version offers optimum protection for the sensor with integrated compressed air cooling and provides protection against fluids.

Option SGL:

Protective housing with open slot for air purging of the measurement gap and cooling purpose.



Dimensions

SGx 16x7/20: 74x80x58mm for
 ILD 16x7-2/4/10/20

SGx 16x7/200: 125x80x58mm for
 ILD16x7-50/100/200

SGx 1800: 140x140x71 mm for
 ILD 1302 and ILD 1402
 ILD 1700-2/10/20/50/100/200/250VT,
 ILD 1700-2LL/10LL/20LL/50LL,
 ILD 2200-2/10/20/50/100,
 ILD 2200-2LL/10LL/20LL/50LL,
 ILD 2220-2/10/20/50/100,
 ILD 2220-2LL/10LL/20LL/50LL

SGx 2200: 140x180x71 mm for
 ILD 1700-40/500/750,
 ILD 2200-40/200,
 ILD 2220-200

IF2008 - PCI interface card

The IF 2008 interface card is designed for installation in PCs and enables the synchronous capture of 4 digital sensor signals and 2 encoders. The absolutely synchronous data acquisition plays an important role particularly for planarity or thickness measurement tasks. The data are stored in a FIFO memory in order to enable resource-saving processing in the PC in blocks.

Particular Benefits

- 4x digital signals and two encoders with basic printed circuit board
- Additional expansion board for a total of 6x digital signals, 2x encoder and 2x analogue signals and 8x I/O Signals
- FIFO data memory
- Synchronous data acquisition

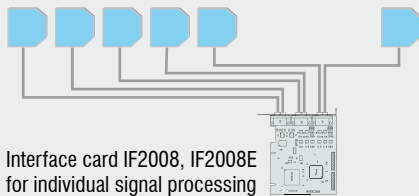

IF2008E - Expansion board

The IF 2008E expansion board is designed for installation in PCs and enables the synchronous capture of 2 digital sensor signals and 2 encoders as well as 8 I/O-Signals. The expansion board is connected to the basis board IF2008. The absolutely synchronous data acquisition plays an important role particularly for planarity or thickness measurement tasks.

Particular Benefits

- Two digital signals, two analogue signals and 8 I/O signals
- Overall with IF2008: 6 digital signals, 2 encoders and 2 analogue signals and 8 I/O Signals
- FIFO data memory
- Synchronous data acquisition

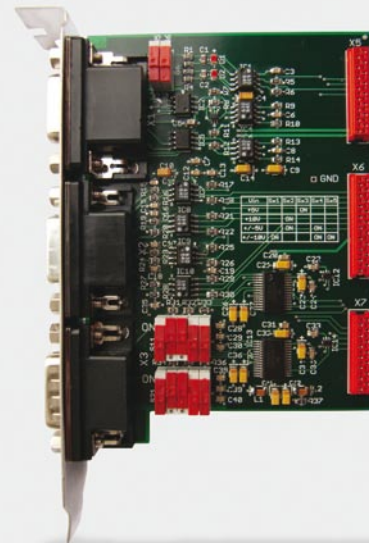

CSP2008 - Universal controller

The CSP2008 controller can be used to process two digital or analogue input signals of almost all Micro-Epsilon displacement sensors (2x internal plus 4x external via Ethercat modules from Beckhoff). Ethercat can also be used as an external interface (master) for connecting further sensors and I/O modules. The controller has a high luminance display so that measured values can be easily read, even from a long distance.

Features

- Real-time processing of input and output signals at upto 100kHz (user selectable)
- Unique user interface for the configuration of the controller via Ethernet on a PC or laptop. All user selectable functions of the controller and the measured values can be viewed, displayed and stored in real time via your own web browser without installing any 3rd part software
- Simple sensor connection with automatic sensor recognition, configuration of the sensor using buttons and display on controller or via laptop
- Modular system upgradable with additional I/O modules for customer-specific requirements. The internal communication between I/O components using Ethercat connection (CSP 2008 acts as master)
- Simple mounting using DIN rail TS 35
- Extremely flexible and powerful functionality; function modules can be combined in many ways. Application example:



Universal controller with DIN rail TS 35
(dimensions not to scale)

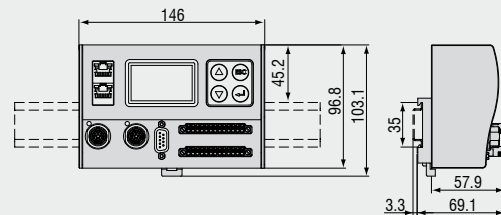

System setup

Sensors via RS422

optoNCDT 1402
optoNCDT 1700
optoNCDT 2200/2220
optoNCDT 2300
optoCONTROL 2500
optoCONTROL 2600
confocalDT

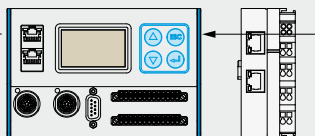

Beckhoff modules for extended inputs / outputs

EK1100 (EtherCat bus coupler)
EL2004 (4 channel digital output terminal 24VDC)
EL4132 (2 channel analogue output terminal for -10...10V, 16Bit)
EL1012/EL1014/EL1018 (2 / 4 / 8 channel digital output terminal for 24V DC)
EL3161/EL3162 (1 / 2 channel analogue output terminal for 0...10V, 16Bit)
EL3141/EL3142 (1 / 2 channel analogue output terminal for 0...20mA, 16Bit)
EL4112 (2 channel analogue output terminal for 0...20mA, 16Bit)
RS422 Extension terminal for CSP2008

High performance sensors made by Micro-Epsilon



Sensors and systems for displacement and position



Sensors and measurement devices for non-contact temperature measurement

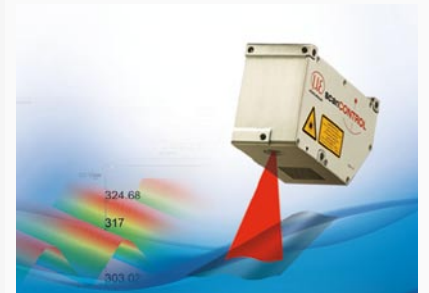

2D/3D profile sensors (laser scanner)

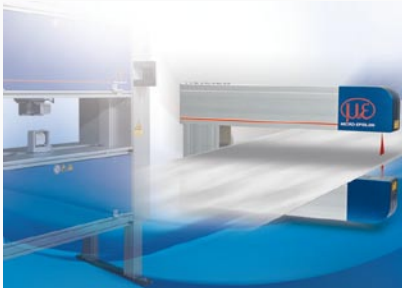

Measurement and inspection systems for quality assurance



Optical micrometers, fiber optic sensors and optical fibers



Color recognition sensors, LED analyzers and color online spectrometer